

Ch05

# The Gas State

"Nothing will ever equal that moment of joyous excitement when I felt myself flying away from the earth."

Jacques Charles, the chemist who made man's first ascent by hydrogen balloon, Dec 1st 1783.



version 1.5

© Nick DeMello, PhD. 2007-2015

J.A.C. Charles launched the first hydrogen balloon on August 27, 1783 from the site that is now the Eiffel tower. It was launched with a sheep as a passenger, as a test for the later manned balloon flights.

The balloon flew for 45 minutes, and outpaced chasers on horseback. It landed 21 km away in the village of Gonesse ...

... where the terrified towns folks attacked it with pitchforks and knives, destroying it.



# Gas State of Matter



## Gas State

- ▶ What's unique about gases?
- ▶ Measuring those properties (V,T,n)
- ▶ Pressure
  - ▶ What is pressure (P)?
    - ▶ Standard Temp. & Pressure (STP)
  - ▶ Instruments and units of pressure.
- ▶ The Simple Gas Laws
  - ▶ Robert Boyle
    - ▶ Scientific Method; P and V; Boyle's Law
  - ▶ Jacques Charles
    - ▶ The Kelvin Scale; V and T Charles' Law
- Joseph Gay-Lussac
  - ▶ The composition of water; T and P Gay-Lussac's Law



- ▶ Combining the Gas Laws
  - ▶ The Combined Gas Law
- ▶ Ideal Gas Theory
  - ▶ Atomic Theory
    - ▶ What is an ideal gas?
  - ▶ Avogadro's Law
  - ▶ Ideal Gas Law
    - ▶ The Ideal Gas Constant (R)
    - ▶ Molar Volume / Gas Stoichiometry
    - ▶ Gas Density
    - ▶ Molar Mass
- ▶ Gas Mixtures
  - ▶ Dalton's Law of Partial Pressures
    - ▶ Mole Fraction
  - ▶ Capturing Gases in the Lab
    - ▶ Vapors & Vapor Pressure
- ▶ Real Gases
  - ▶ Non-ideal conditions

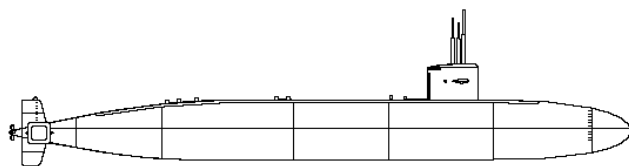
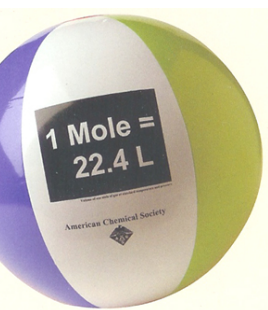
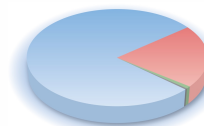



# Three States of Matter

- ▶ Matter can exist three different ways.
  - ▶ It can be tightly packed (solid)
  - ▶ It can be wadded up randomly (liquid)
  - ▶ It can be stretched thin (gas)
- ▶ It's still the same matter, just in a different state.
- ▶ Like your favorite shirt can be neatly folded, wadded up, or stretched over a coat hanger.
- ▶ It still the same shirt, but being in a different state means it may have some different properties.





# Three States of Matter

- ▶ The same sample of matter, when it's in the gas state...
  - ▶ Is much more compressible than as a liquid or solid.
    - ▶ Easy to change it's volume.
  - ▶ It has much more energy than if were in the solid or liquid state.
    - ▶ Higher temperature.
  - ▶ It's much less dense.
    - ▶ Less substance in the same space.
  
- ▶ To understand the gas state of matter scientists made observations of these measurable properties and tried to understand how they were related.
  - ▶ The volume of gases (V)
  - ▶ Their temperature (T)
  - ▶ The amount of substance (n)

properties	Gas	Liquid	Solid
Shape	Variable	Variable	Fixed
Volume	Variable	Fixed	Fixed
Compressible	Extremely	Slight	None
Structure	Flexible	Flexible	Fixed
Density	Least	Compact	Most
Cohesion	Least	Between	Most
Energy	Most	Between	Least



# Gas State of Matter

## ▶ Gas State

- ▶ What's unique about gases?
- ▶ Measuring those properties (V,T,n)



## Pressure

- ▶ What is pressure (P)?
  - ▶ Standard Temp. & Pressure (STP)
- ▶ Instruments and units of pressure.

## ▶ The Simple Gas Laws

- ▶ Robert Boyle
  - ▶ Scientific Method; P and V; Boyle's Law
- ▶ Jacques Charles
  - ▶ The Kelvin Scale; V and T Charles' Law



## Joseph Gay-Lussac

- ▶ The composition of water; T and P Gay-Lussac's Law

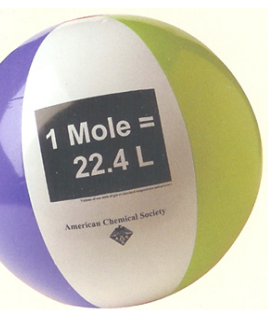

## ▶ Combining the Gas Laws

- ▶ The Combined Gas Law

## ▶ Ideal Gas Theory

- ▶ Atomic Theory
  - ▶ What is an ideal gas?
- ▶ Avogadro's Law
- ▶ Ideal Gas Law
  - ▶ The Ideal Gas Constant (R)
  - ▶ Molar Volume / Gas Stoichiometry
  - ▶ Gas Density
  - ▶ Molar Mass



## ▶ Gas Mixtures

- ▶ Dalton's Law of Partial Pressures
  - ▶ Mole Fraction
- ▶ Capturing Gases in the Lab
  - ▶ Vapors & Vapor Pressure

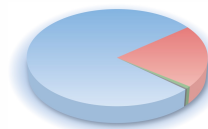

## ▶ Real Gases

- ▶ Non-ideal conditions

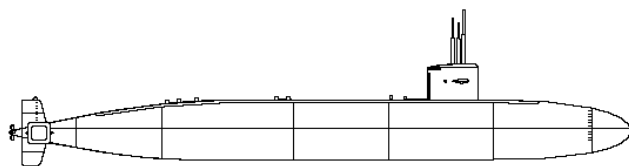

# Pressure

- ▶ They also looked at pressure.
- ▶ **Pressure** is force per unit area.
- ▶ When someone fires a rifle, the force pushing the bullet forward is equal to the force pushing the rifle into their shoulder.
- ▶ The bullet does more damage to the target than the stock does to the shoulder.
  - ▶ Because all the force in the bullet is concentrated into a small area at the tip of the bullet.
  - ▶ While the stock spreads the force out over a larger area.
- ▶ Both apply the same force.
- ▶ The point the bullet impacts feels more pressure.

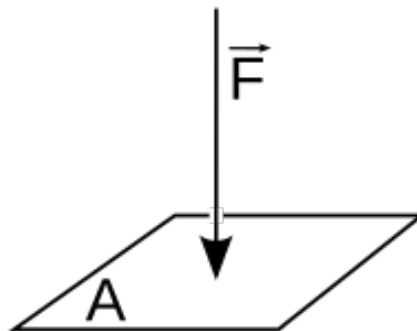

$$\text{Pressure} = \frac{\text{Force}}{\text{Area}}$$





# Gas Pressure

- ▶ Gases are always trying to expand.
- ▶ Gases apply pressure to whatever container holds them and to anything that shares the container with them.
- ▶ The particles of gas hit the walls and each collision applies a force.
- ▶ Pressure is harder to measure than temperature, volume or mass.

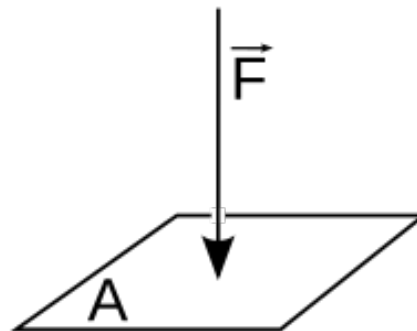
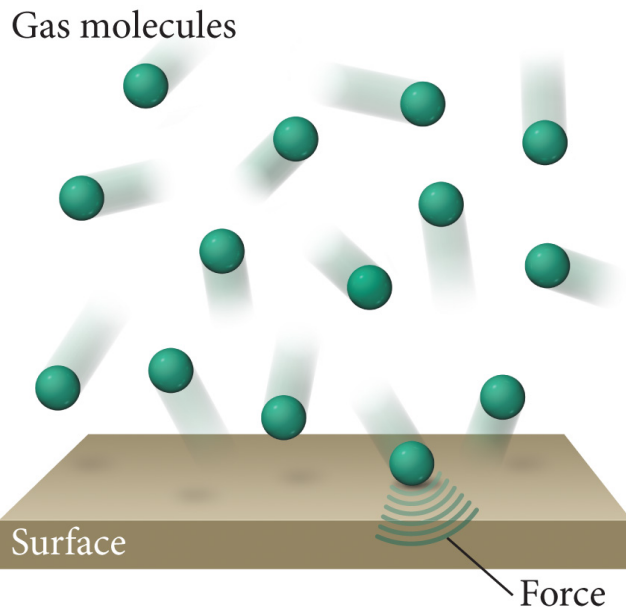
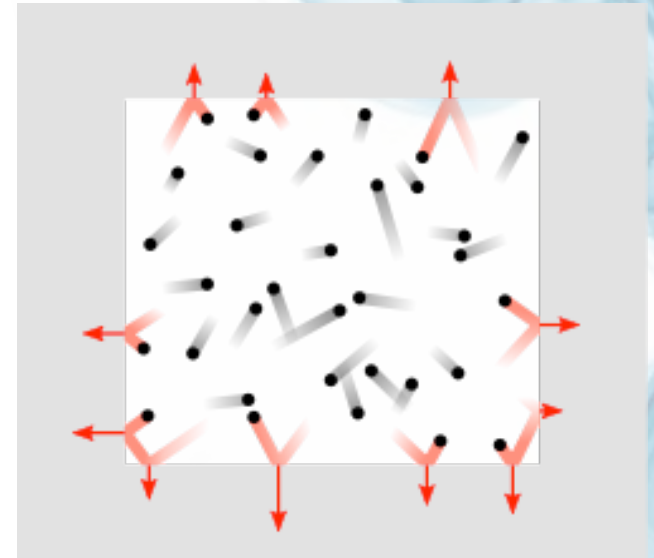

$$\text{Pressure} = \frac{\text{Force}}{\text{Area}}$$

# Measuring Pressure

- ▶ **Barometers** measure pressure.
- ▶ If you turn a tube of mercury upside down, gravity applies force ... and it flows out.
- ▶ If you put that tube in a pool of mercury as you turn it, the mercury coming out has to push up the surface of the pool.
  - ▶ The pressure of the air around us is pushing the surface of the pool down.
    - ▶ The amount of mercury (per area) will get smaller as mercury runs out.
    - ▶ When the amount mercury (per area) is small enough that force as the gravity acting on it is equal to the force (per area) of the gas pushing down on the pool – it stops flowing.
    - ▶ And some height of mercury stays in the tube.
- ▶ The height of mercury that is kept up by the gas is a measure of it's pressure.
- ▶ At sea level, Earth's atmosphere applies enough pressure to hold up 760. mm of mercury.

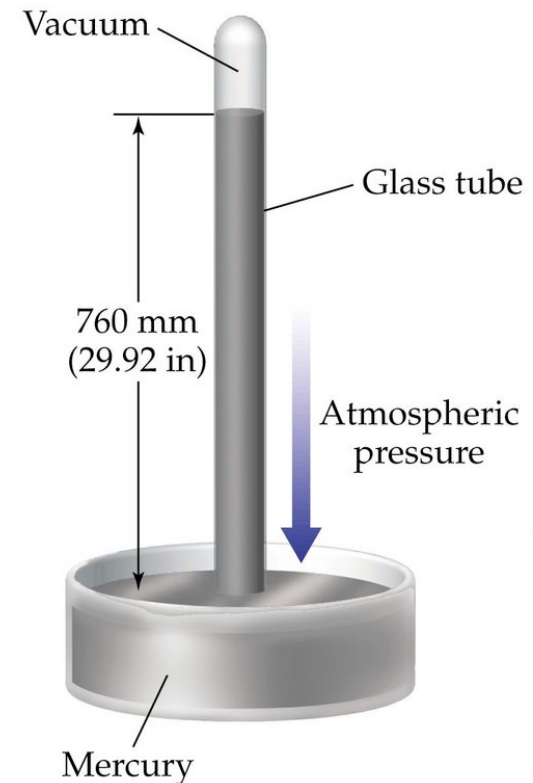

# Measuring Pressure

- ▶ We live at the bottom of an ocean of gas particles.
- ▶ The particles are constantly striking us and applying force to everything around us.
- ▶ Normal atmospheric pressure at sea level is referred to as **standard pressure**.
  - ▶ As you go to higher altitudes there are less gas particles.
  - ▶ Less gas particles means less pressure.
  - ▶ Altitude is therefore proportional to atmospheric pressure.
- ▶ A **barometer** measures atmospheric pressure in our environment.
  - ▶ A tube of mercury is inverted and placed in a dish of mercury.
  - ▶ Gravity pulls the mercury down; atmosphere pushes it up.
  - ▶ The number of millimeters of liquid supported by the collisions is the measure of pressure.

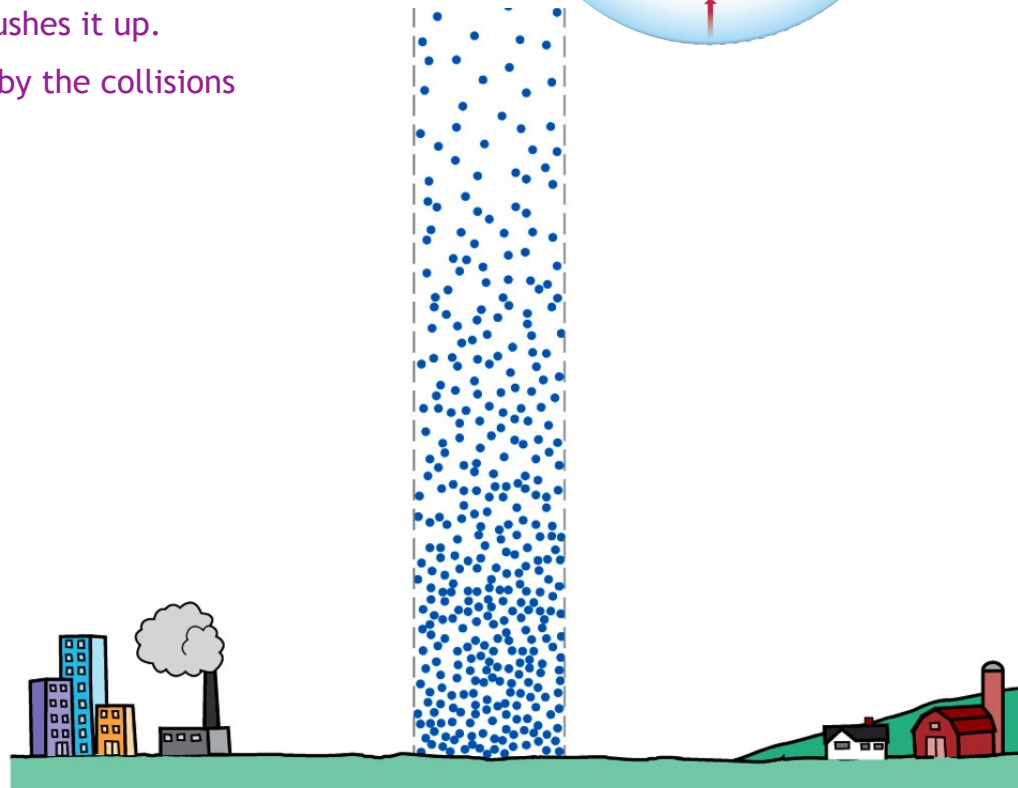
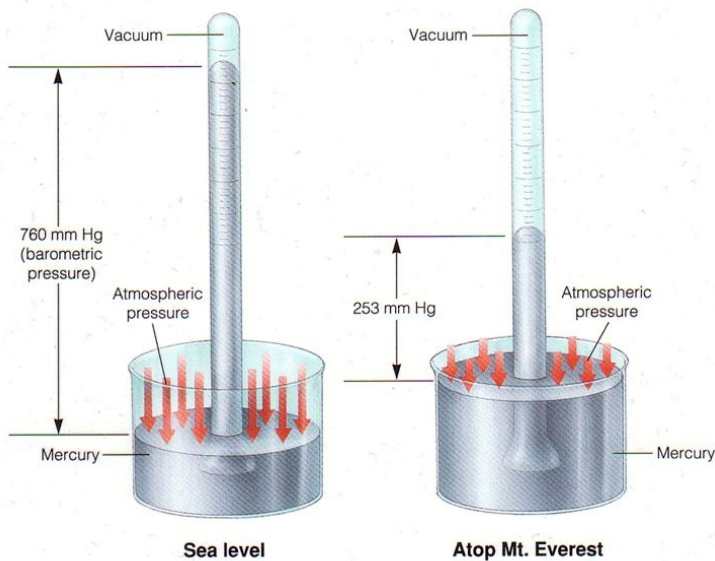
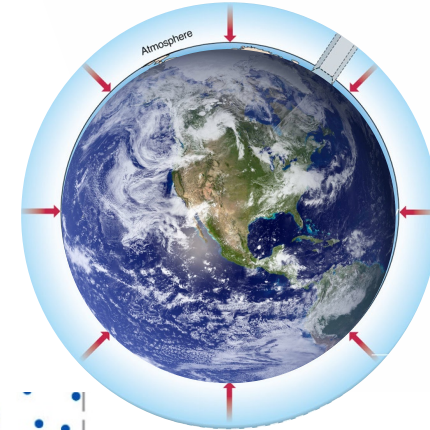



# Measuring Pressure

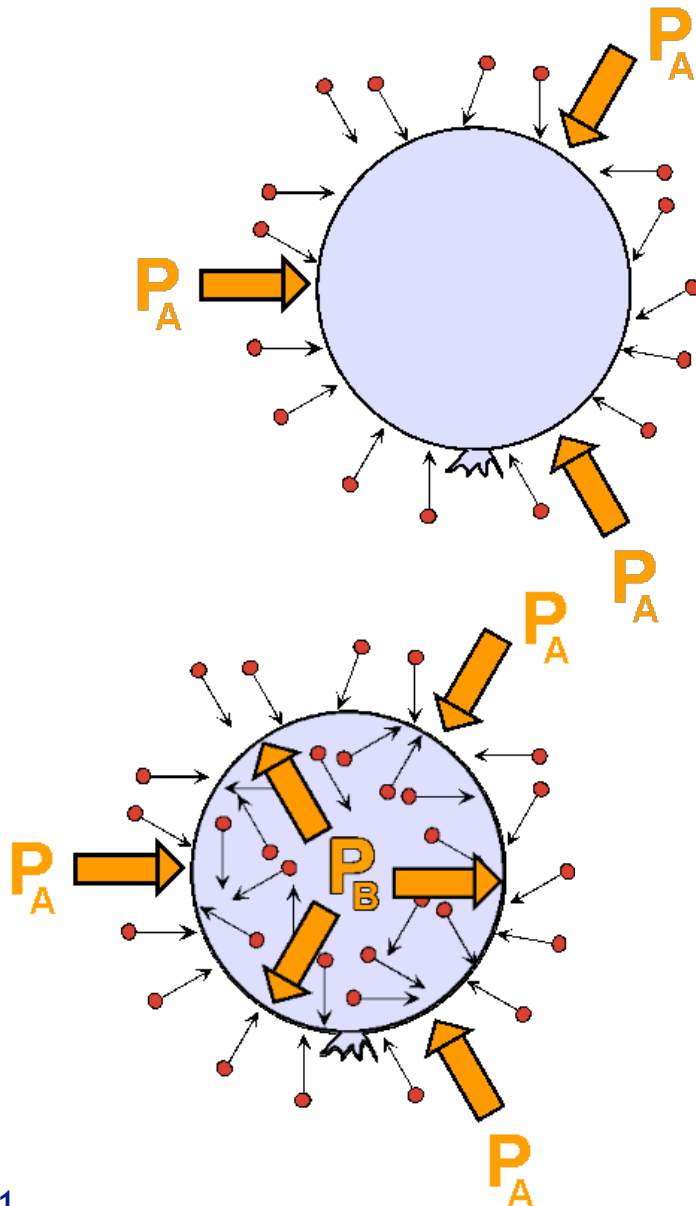

- ▶ Gases apply pressure to objects within the gas, like the earth's atmosphere presses on you, me and a balloon floating in the air.
- ▶ Gases can also apply pressure from within a container.
- ▶ The reason a balloon maintains a certain size is because the gas inside and outside have the same pressure.
- ▶ It's possible for some containers to hold gases at a different pressure.
- ▶ We use a different instrument to measure the pressure inside these containers.



# Measuring Pressure

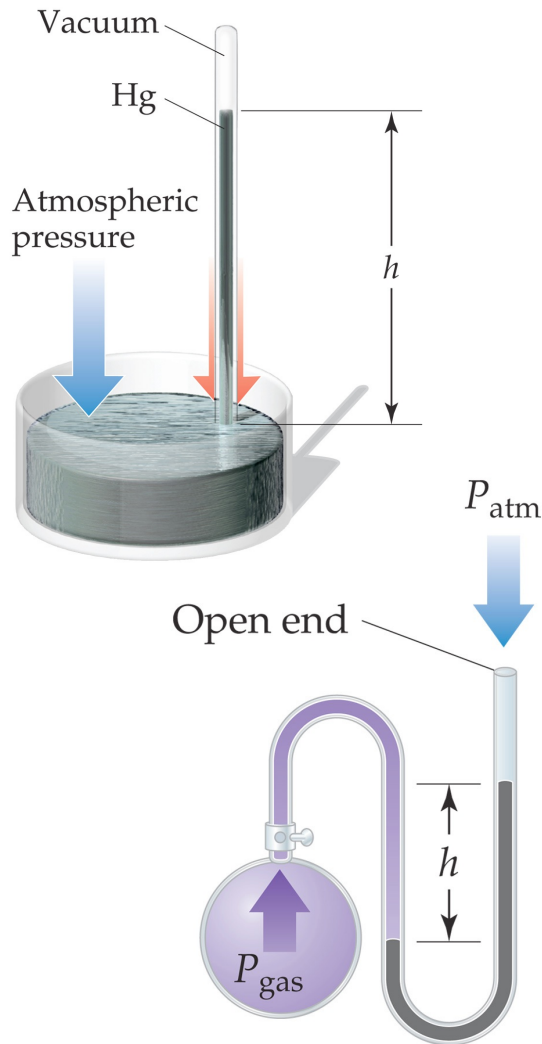

$$P_{\text{gas}} = P_{\text{atm}} + P_h$$

- ▶ A **barometer** measures atmospheric pressure by seeing how many millimeters of liquid can be supported by ambient pressure.
  - ▶ A tube of mercury is inverted and placed in a dish of mercury.
  - ▶ Gravity pulls the mercury down; atmosphere pushes it up.
  - ▶ Normal atmospheric pressure at sea level is referred to as standard pressure.
    - ▶ A barometer reports what height of mercury the pressure can support.
- ▶ A **manometer** measures pressure in a closed system by comparing it to atmospheric pressure.
  - ▶ The difference in pressure is observed as a difference in heights of mercury.
  - ▶ The pressure inside the tube is recorded relative to the outside pressure.
    - ▶ A manometer reports the difference in pressure between a the gas in a container and the gas outside it.

# Measuring Pressure

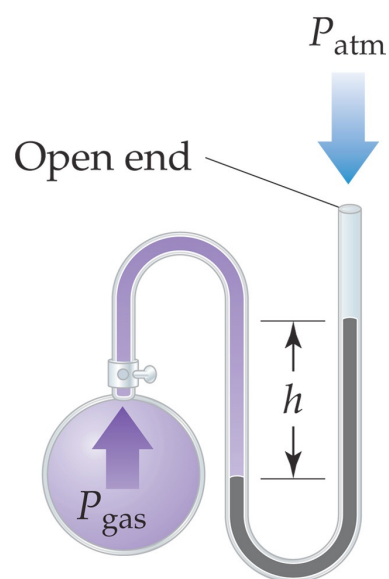

$$P_{\text{gas}} = P_{\text{atm}} + P_h$$

- ▶ A **manometer** measures pressure in a closed system by comparing it to atmospheric pressure.
  - ▶ The difference in pressure is observed as a difference in heights of mercury.
  - ▶ The pressure inside the tube is recorded relative to the outside pressure.
    - ▶ A manometer reports the difference in pressure between a the gas in a container and the gas outside it.

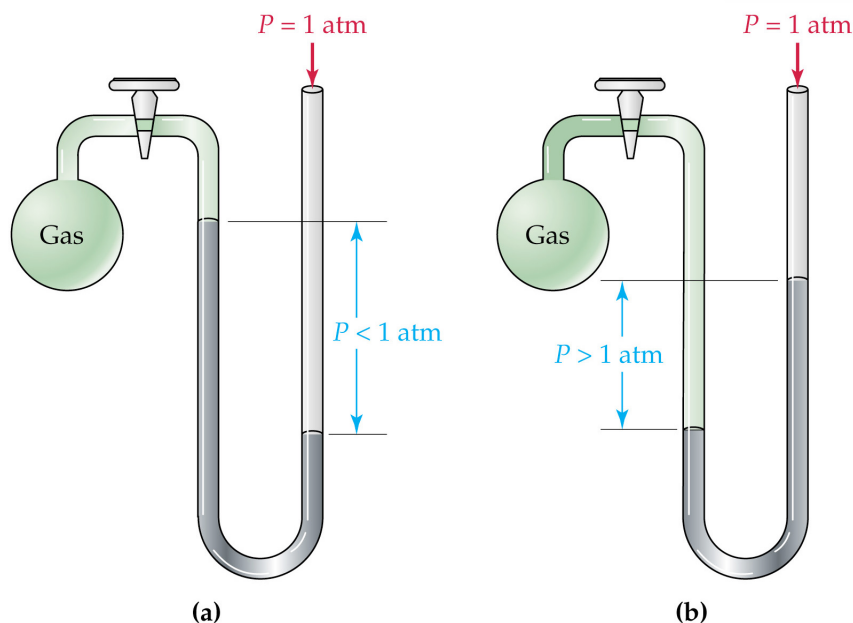



# Converting Units of Pressure

- ▶ Normal atmospheric pressure at sea level is referred to as **standard pressure**.
- ▶ When discussing gases, we'll also talk about **standard temperature** (exactly 0°C).
- ▶ There are a lot of units of pressure.
- ▶ You responsible for units of:
  - ▶ atm (atmospheres)
  - ▶ mmHg (millimeters of mercury)
  - ▶ torr (another way to say mmHg)
- ▶ The conversion factors you will need are:

1 atm measures 760. mmHg (3 sig figs)  
1 torr is defined to be 1 mmHg (exactly)

- ▶ **STP** means standard temperature and pressure.

1 atm

760 torr  
760 mm Hg  
76 cm Hg  
101.325 kPa  
1013 mbar  
29.9 in. Hg  
14.7 lb/in.<sup>2</sup>

You are responsible for these two conversion factors!



# Gas State of Matter

## ▶ Gas State

- ▶ What's unique about gases?
- ▶ Measuring those properties (V,T,n)

## ▶ Pressure

- ▶ What is pressure (P)?
  - ▶ Standard Temp. & Pressure (STP)
- ▶ Instruments and units of pressure.

## ▶ The Simple Gas Laws



### Robert Boyle

- ▶ Scientific Method; P and V;  
Boyle's Law

### ▶ Jacques Charles

- ▶ The Kelvin Scale; V and T  
Charles' Law

### Joseph Gay-Lussac

- ▶ The composition of water; T and P  
Gay-Lussac's Law



## ▶ Combining the Gas Laws

- ▶ The Combined Gas Law

## ▶ Ideal Gas Theory

- ▶ Atomic Theory
  - ▶ What is an ideal gas?

## ▶ Avogadro's Law

## ▶ Ideal Gas Law

- ▶ The Ideal Gas Constant (R)
- ▶ Molar Volume / Gas Stoichiometry
- ▶ Gas Density
- ▶ Molar Mass



## ▶ Gas Mixtures

- ▶ Dalton's Law of Partial Pressures
  - ▶ Mole Fraction
- ▶ Capturing Gases in the Lab
  - ▶ Vapors & Vapor Pressure

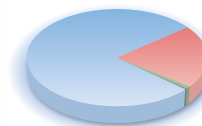

## ▶ Real Gases

- ▶ Non-ideal conditions

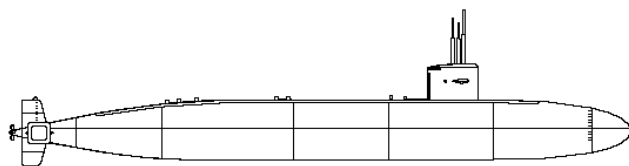
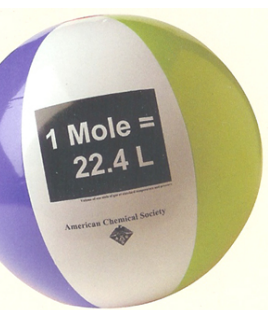

# Robert Boyle

- ▶ Robert Boyle was a Irish alchemist who lived from 1627-1691.
- ▶ Boyle argued for a rigorous exploration of the composition of matter based on observation and experiment.
- ▶ Boyle published 46 books including the *Sceptical Chymist* in 1661.
  - ▶ The book which formalized and advocated the ideas which we now describe as scientific method.
  - ▶ The book which laid the foundation for the modern idea of elements.
- ▶ Boyle is often regarded as the first modern chemist and the founder of modern chemistry.
- ▶ He pioneered a study he called **chemical analysis** and offered experiments to demonstrate the distinction between mixtures and compounds.
- ▶ He studied combustion, respiration and wrote the definitive work of his time on the composition of air.

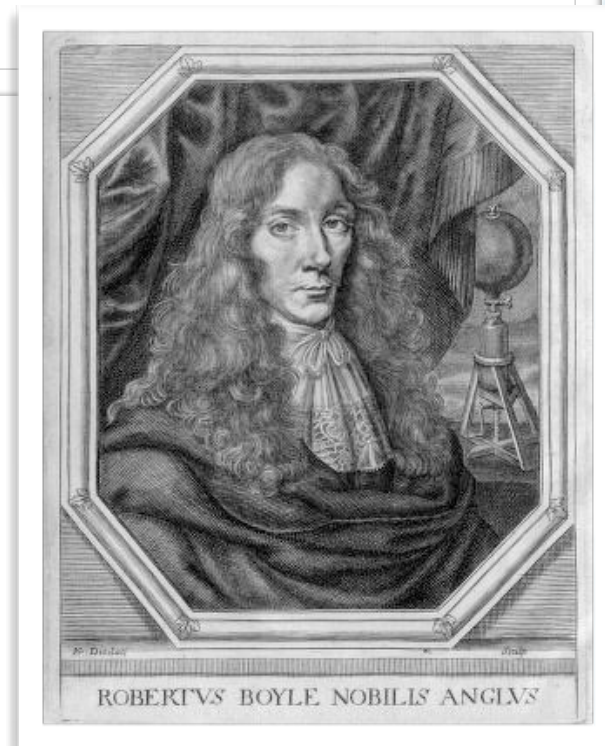

Robert Boyle  
1627-1691

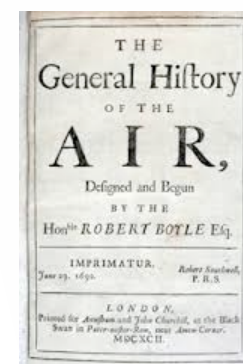



# Robert Boyle

- ▶ Boyle did many experiments on the composition and properties of gases.
- ▶ He observed:
  - ▶ As the pressure (P) of on gases increased, the volume (V) shrank.
  - ▶ As he forced gases into smaller volumes (V), their pressure (P) rose.
- ▶ This was true regardless of which gas he observed.

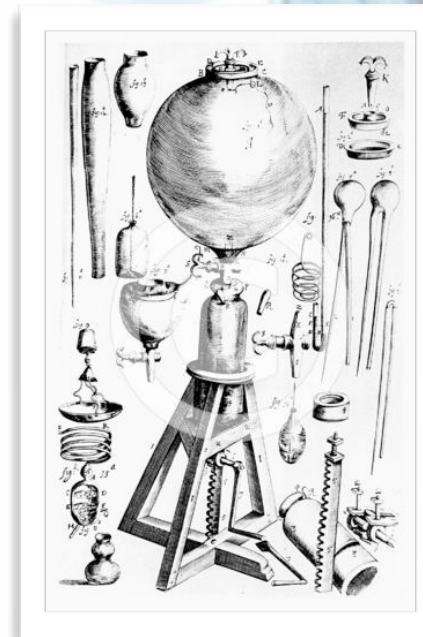
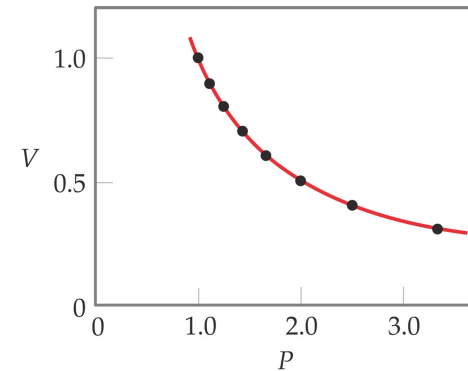

$P \downarrow \quad V \uparrow$   
 $P \uparrow \quad V \downarrow$

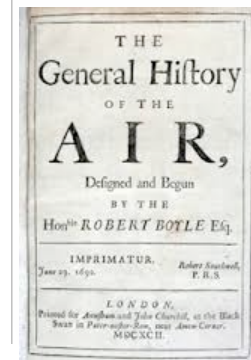
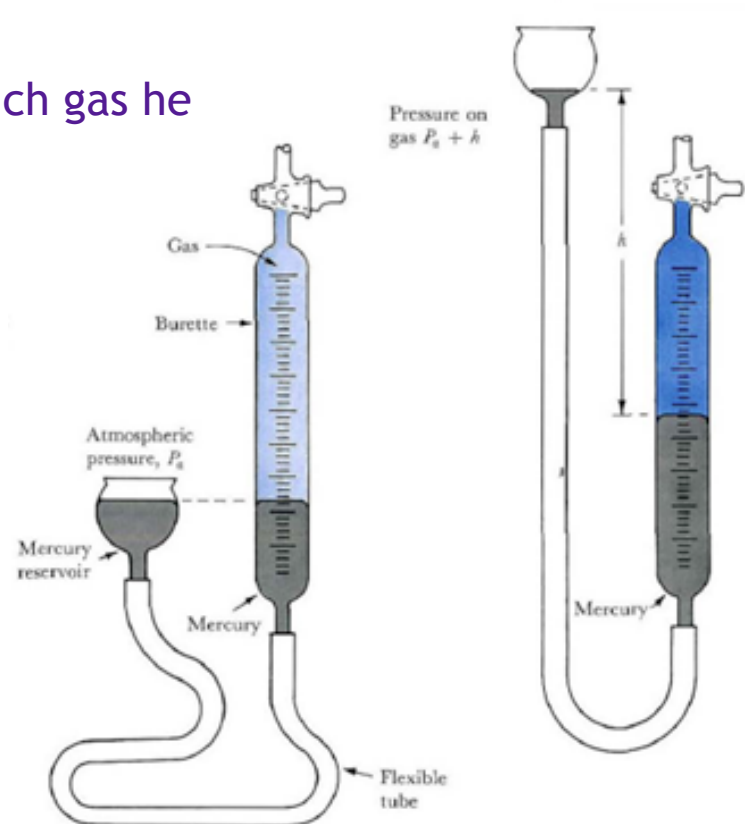

# Boyle's Law

Boyle's Law:

$$P \times V = k$$

$$P_B \times V_B = P_A \times V_A$$

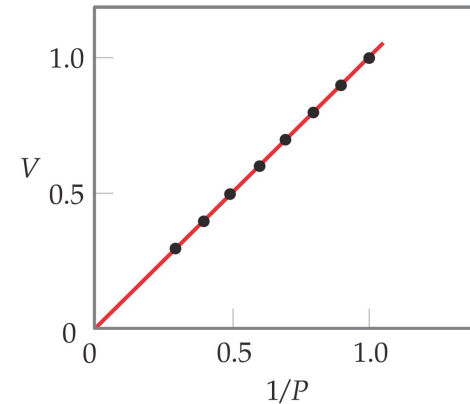

$$V = k (1/P)$$

- ▶ Plotting  $V$  against  $1/P$  for his experiments...

- ▶ He found there was a direct relationship between volume and pressure.
- ▶ For any experiment he setup, the ratio of  $P \times V$  never changed as he varied pressure or volume.
- ▶ Once you know the constant ( $k$ ) for a sample, you can predict volume or pressure.

- ▶ These observations are Boyle's law.

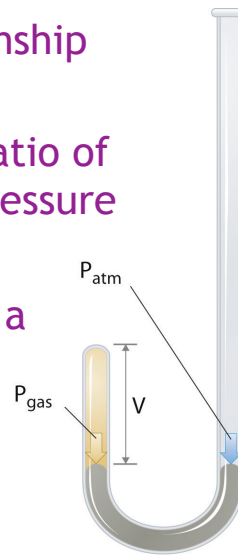

(a)  
 $V_{\text{gas}} = V$   
 $P_{\text{gas}} = 760 \text{ mmHg}$

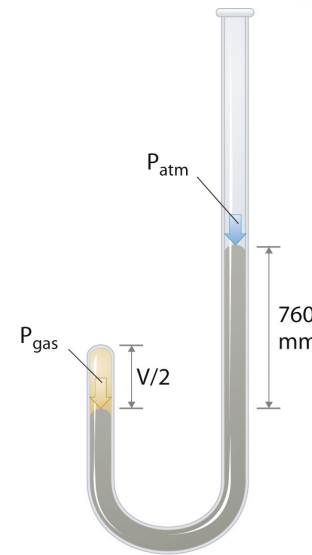

(b)  
 $V_{\text{gas}} = V/2$   
 $P_{\text{gas}} = 1520 \text{ mmHg}$

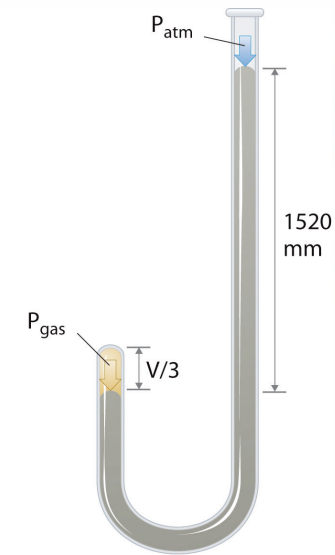

(c)  
 $V_{\text{gas}} = V/3$   
 $P_{\text{gas}} = 2280 \text{ mmHg}$

## Boyle's Law Problem

If Robert Boyle started with a 2.45 liters of gas at 758 mmHg and added enough weight to the shrink the volume of gas to 0.31 liters, what would be the pressure of the gas? What is that pressure in atm?

$$P_A = P_B \frac{V_B}{V_A}$$

$$= 758 \text{ mm Hg} \cdot \frac{2.45 \text{ L}}{0.31 \text{ L}}$$

$$= 5,990.64516 \text{ mm Hg}$$

$$= \underline{6.0 \times 10^3 \text{ mm Hg}}$$

$$P = 6.0 \times 10^3 \text{ mm Hg} \times \frac{1 \text{ atm}}{760. \text{ mm Hg}}$$

$$= 7.8947368 \text{ atm} = \underline{7.9 \text{ atm}}$$

Boyle's Law

$$P_A V_A = P_B V_B$$

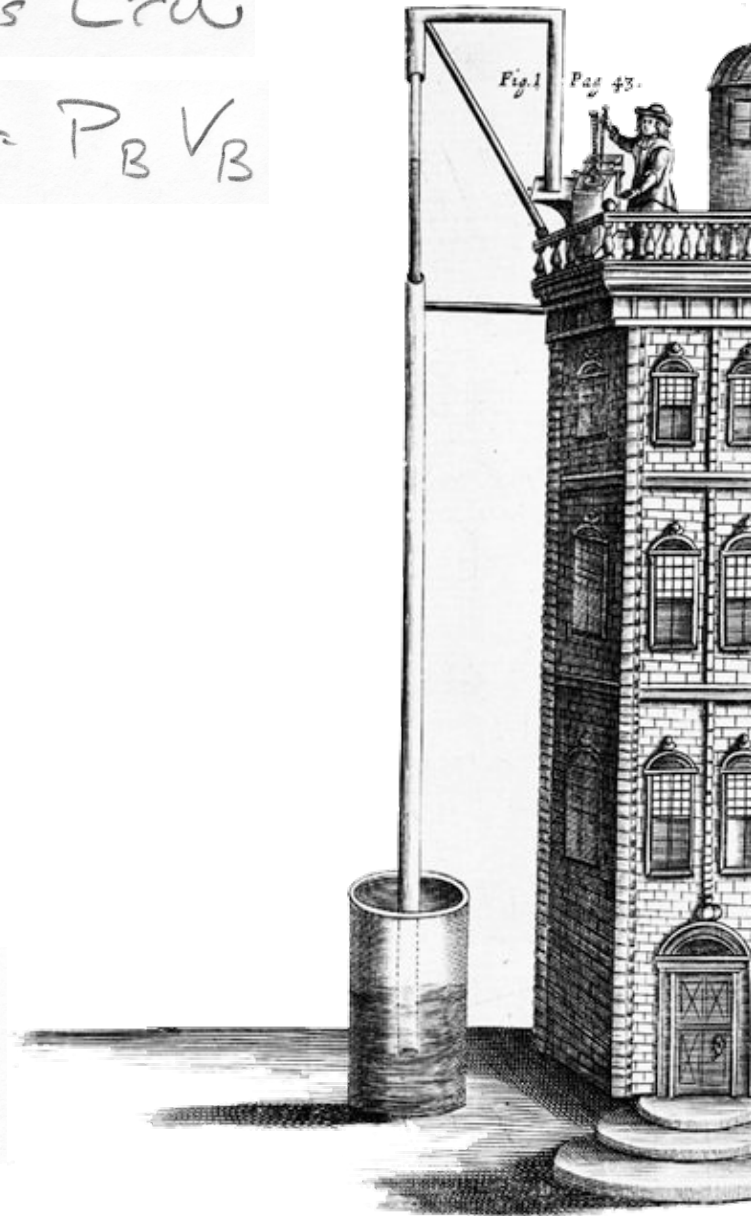

# Gas State of Matter

- ▶ Gas State
  - ▶ What's unique about gases?
  - ▶ Measuring those properties (V,T,n)
- ▶ Pressure
  - ▶ What is pressure (P)?
    - ▶ Standard Temp. & Pressure (STP)
  - ▶ Instruments and units of pressure.
- ▶ The Simple Gas Laws
  - ▶ Robert Boyle
    - ▶ Scientific Method; P and V; Boyle's Law
  - ▶ Jacques Charles
    - ▶ The Kelvin Scale; V and T Charles' Law
  - ▶ Joseph Gay-Lussac
    - ▶ The composition of water; T and P Gay-Lussac's Law
- ▶ Combining the Gas Laws
  - ▶ The Combined Gas Law
- ▶ Ideal Gas Theory
  - ▶ Atomic Theory
    - ▶ What is an ideal gas?
  - ▶ Avogadro's Law
  - ▶ Ideal Gas Law
    - ▶ The Ideal Gas Constant (R)
    - ▶ Molar Volume / Gas Stoichiometry
    - ▶ Gas Density
    - ▶ Molar Mass
- ▶ Gas Mixtures
  - ▶ Dalton's Law of Partial Pressures
    - ▶ Mole Fraction
  - ▶ Capturing Gases in the Lab
    - ▶ Vapors & Vapor Pressure
- ▶ Real Gases
  - ▶ Non-ideal conditions

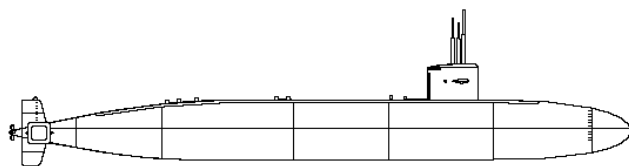
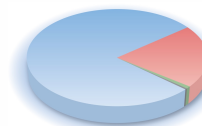
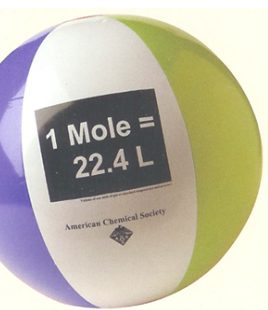



# Jacques A.C. Charles

- ▶ Prof. Jacques Alexandre César Charles was a Parisian inventor, chemist, mathematician, and balloonist.
- ▶ Manned flight began in 1783, the first manned flight using a hot air balloon was accomplished in Paris.
  - ▶ J.A.C. Charles & Jacques-Étienne Montgolfier designed the balloon and were to pilot it, but King Louis the XVI refused to risk Charles in the test.
- ▶ Benjamin Franklin witnessed the balloon take off and wrote:

"We observed it lift off in the most majestic manner. When it reached around 250 feet in altitude, the intrepid voyagers lowered their hats to salute the spectators.  
We could not help feeling a certain mixture of awe and admiration."
- ▶ Ten days later, at J.A.C. Charles insistence, he piloted a different kind of balloon one that didn't require fuel to heat the air.
  - ▶ Charles balloon floated in air because the hydrogen gas it held is less dense than air even at very cold temperatures.
  - ▶ Over 400,000 spectators gathered to see a many rise higher than we every imagined possible.
- ▶ Charles soared to the incredible height of 3,000 feet where he took reading of temperature and pressure before the ringing in his ears forced him to land.



J.A.C. Charles  
1746-1823

Piloted man's first ascent in a hydrogen balloon (1783).



# Jacques A.C. Charles

- ▶ Charles filled his hydrogen balloon by pouring a quarter of a ton of sulphuric acid onto half a ton of scrap iron.



- ▶ Charles' observed how the gas balloon would expand or shrink with changes in temperature.
  - ▶ The heat created by the chemical reaction caused the balloon to expand tremendously.
  - ▶ Each night it would shrink as the day cooled.
- ▶ Charles' observed that temperature and volume of a gas are proportional.
- ▶ This is true for all gases.

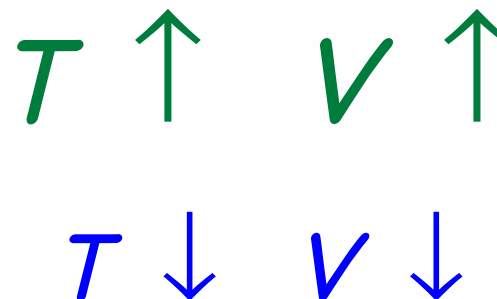

# The Kelvin Scale

- ▶ If a given volume of any gas at  $0^{\circ}\text{C}$  is cooled by  $1^{\circ}\text{C}$  the volume of the gas decreases by  $\frac{1}{273}$
  - ▶ If a given volume of any gas at  $0^{\circ}\text{C}$  is cooled by  $20^{\circ}\text{C}$  the volume of the gas decreases by  $\frac{20}{273}$
  - ▶ If a given volume of any gas at  $0^{\circ}\text{C}$  is cooled by  $273^{\circ}\text{C}$  the volume of the gas decreases by  $\frac{273}{273}$
- 
- ▶ This suggests  $-273^{\circ}\text{C}$  (more precisely  $-273.15^{\circ}\text{C}$ ) is an absolute zero of temperature.
  - ▶ It is the temperature at which a gas would have 0 volume.
  - ▶ The Kelvin temperature scale is based on this absolute zero.
  - ▶ We have never observed  $-273.15$ , we can only guess what would happen if something really got that cold.

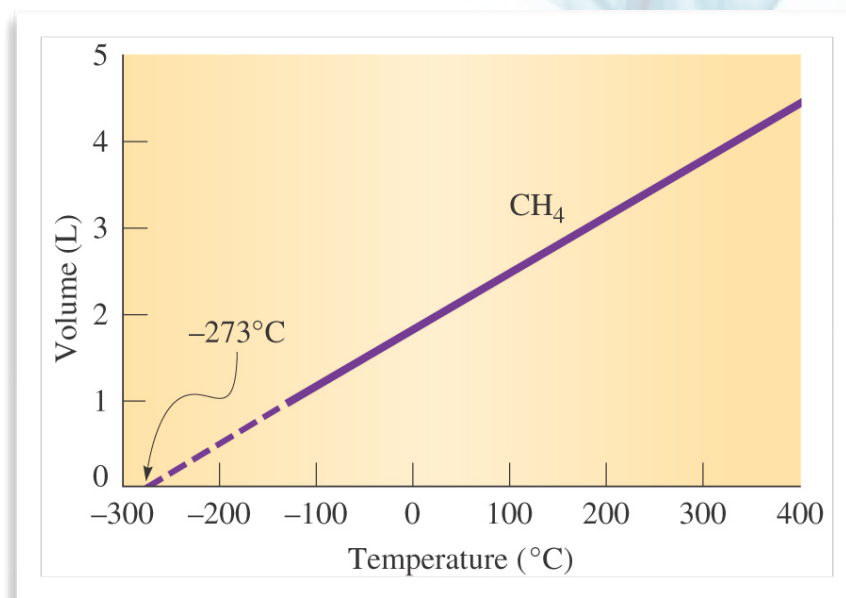

Every gas law calculation you do in this chapter must be done in Kelvin, if you do not convert Celsius to Kelvin, you'll get the wrong answer!

# Essential Conversion Factors into SI

Length	$2.54 \text{ cm} = 1 \text{ inch}$ (exact)
Mass	$1 \text{ kg} = 2.2 \text{ lbs}$ (not exact)
Time	60 sec = 1 min; 60 min = 1 hr; 24 hr = 1 day; 365 day = 1 year (all exact)
Temperature	$y \text{ K} = x \text{ }^\circ\text{C} + 273.15$ (not exact)
Count	$1 \text{ mol} = 6.022 \times 10^{23}$ singles (not exact)
<b>Memorize these! for now, any other conversion factors will be provided</b>	

(all standard units are now based on SI units with the exception of the

Every gas law calculation you do in this chapter must be done in Kelvin, if you do not convert Celsius to Kelvin, you'll get the wrong answer!



# Charles' Law

- ▶ Charles' observations can be summarized with the law named after him, Charles' law.
  - ▶ Charles' law is only reliable if you have temperature in units of Kelvin.
- ▶  $k$  is different for each sample of gas, but it's consistent for that gas when you change either it's volume or temperature.
- ▶ Charles' law let's you predict what will happen with volume temperature changes.

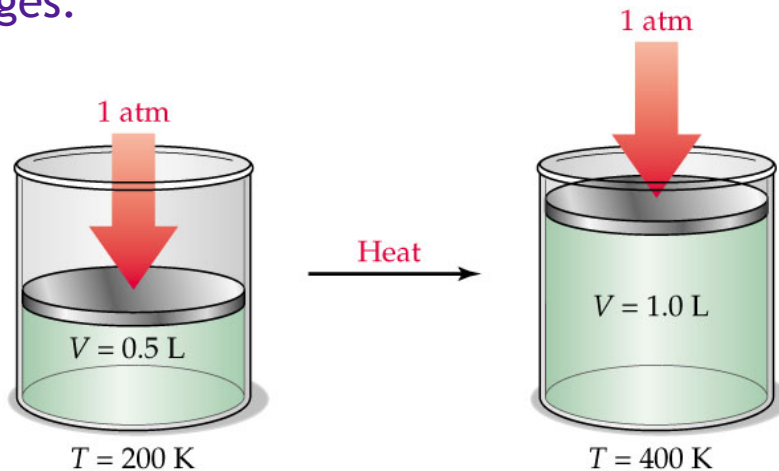

## Charles' Law:

$$\frac{V}{T} = k$$

$$\frac{V_B}{T_B} = \frac{V_A}{T_A}$$



Every gas law calculation you do in this chapter must be done in Kelvin, if you do not convert Celsius to Kelvin, you'll get the wrong answer!

## Charles' Law Problem

The buoyancy of a passenger balloon is a result of it's volume. Too small a ballon won't hold you up. If you filled a balloon to 74,000 kL at 25°C and it cooled to -11°C, what would it's volume be?

$$\begin{array}{r} T_{\text{BEFORE}} = 25^{\circ}\text{C} \\ 273.15 \\ \hline 298.15 \\ 298\text{ K} \end{array}$$

$$\begin{array}{r} T_{\text{AFTER}} = -11^{\circ}\text{C} \\ + 273.15 \\ \hline 262.15 \\ 262\text{ K} \end{array}$$

Charles' Law

$$\frac{V_A}{T_A} = \frac{V_B}{T_B}$$

$$V_A = \frac{T_A}{T_B} V_B$$

$$= \frac{262\text{ K}}{298\text{ K}} \times 74,000\text{ KL}$$

$$= 65,060.4027\text{ KL}$$

$$= \boxed{6.5 \times 10^4\text{ KL}}$$



# Gas State of Matter

- ▶ Gas State
  - ▶ What's unique about gases?
  - ▶ Measuring those properties (V,T,n)
- ▶ Pressure
  - ▶ What is pressure (P)?
    - ▶ Standard Temp. & Pressure (STP)
  - ▶ Instruments and units of pressure.
- ▶ The Simple Gas Laws
  - ▶ Robert Boyle
    - ▶ Scientific Method; P and V; Boyle's Law
  - ▶ Jacques Charles
    - ▶ The Kelvin Scale; V and T Charles' Law
  - ▶ Joseph Gay-Lussac
    - ▶ The composition of water; T and P Gay-Lussac's Law
- ▶ Combining the Gas Laws
  - ▶ The Combined Gas Law
- ▶ Ideal Gas Theory
  - ▶ Atomic Theory
    - ▶ What is an ideal gas?
  - ▶ Avogadro's Law
  - ▶ Ideal Gas Law
    - ▶ The Ideal Gas Constant (R)
    - ▶ Molar Volume / Gas Stoichiometry
    - ▶ Gas Density
    - ▶ Molar Mass
- ▶ Gas Mixtures
  - ▶ Dalton's Law of Partial Pressures
    - ▶ Mole Fraction
  - ▶ Capturing Gases in the Lab
    - ▶ Vapors & Vapor Pressure
- ▶ Real Gases
  - ▶ Non-ideal conditions

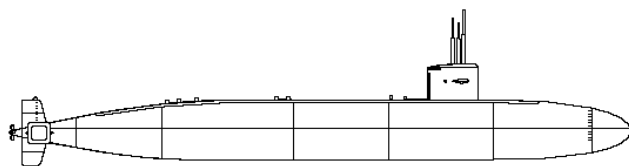
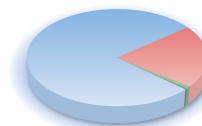
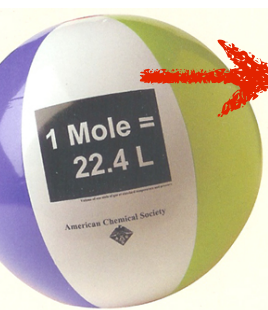

# Joseph Gay-Lussac

- ▶ Joseph Louis Gay was a French chemist and businessman.
  - ▶ He owned much of the town Lussac and usually appended it's name to his own.
- ▶ He discovered the elements boron and iodine.
- ▶ He refined and coined the term for many instruments including the pipette and burette.
- ▶ He used hydrogen balloons to explore water vapor at different heights in our atmosphere, up to 7000 meters.
- ▶ He discovered that water is formed by two parts of hydrogen and one part of oxygen (by volume).
- ▶ Gay-Lussac formalized Jacques Charles' observations, he also published his own observations relating temperature and pressure.
- ▶ Gay-Lussac observed that temperature and pressure are directly proportional.

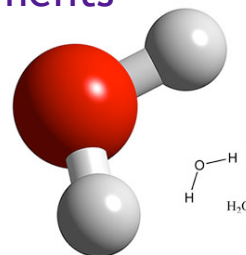

Joseph Gay-Lussac  
1778-1850

Discovered the elements  
Boron & Iodine and named  
of the pipette and burette.

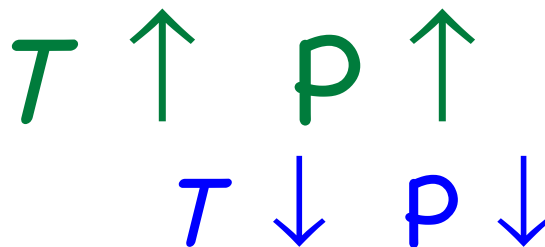



# Joseph Gay-Lussac

- ▶ Gay-Lussac's observations are summarized by the third gas law, Gay-Lussac's law.
- ▶ Gay-Lussac's law states that the pressure of a gas at fixed volume is directly proportional to the gas's *absolute* temperature.

## Gay-Lussac's Law:

$$\frac{P}{T} = k$$

Temperature must be in Kelvin!

$$\frac{P_B}{T_B} = \frac{P_A}{T_A}$$

$$\begin{array}{cc} T \uparrow & P \uparrow \\ T \downarrow & P \downarrow \end{array}$$

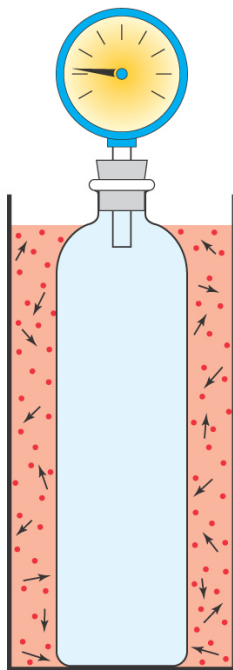

0°C  
Volume = 1 liter  
0.1 mole gas  
P = 2.24 atm

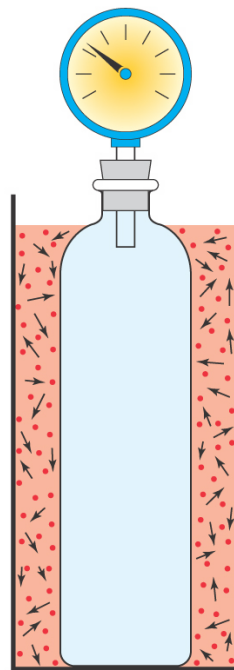

100°C  
Volume = 1 liter  
0.1 mole gas  
P = 3.06 atm

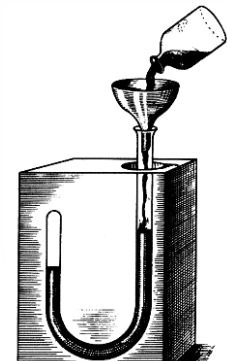

## Gay-Lussac's Law Problem

If a compressed gas at 25.2°C and 3.45 atm was released into a room that was under 1.00 atm of pressure, what would the temperature of the gas become?

Gay-Lussac's Law

$$\frac{P_B}{T_B} = \frac{P_A}{T_A}$$

$$T_A P_B = T_B P_A$$

$$T_A = T_B \frac{P_A}{P_B}$$

$$= 298.4 \text{ K} \frac{1.00 \text{ atm}}{3.45 \text{ atm}}$$

$$= 86.4927536 \text{ K}$$

$$= \underline{86.5 \text{ K}}$$

$$\begin{array}{r} T_{\text{BEFORE}} = 25.2 \text{ }^\circ\text{C} \\ + 273.15 \\ \hline 298.35 \\ \hline 298.4 \text{ K} \end{array}$$

Temperature must  
be in Kelvin!

$$\begin{array}{r} 86.5 \text{ K} \\ - 273.15 \\ \hline -186.65 \\ \hline -186.7 \text{ }^\circ\text{C} \end{array}$$



# Gas State of Matter

## ▶ Gas State

- ▶ What's unique about gases?
- ▶ Measuring those properties (V,T,n)

## ▶ Pressure

- ▶ What is pressure (P)?
  - ▶ Standard Temp. & Pressure (STP)
- ▶ Instruments and units of pressure.

## ▶ The Simple Gas Laws

### ▶ Robert Boyle

- ▶ Scientific Method; P and V;  
Boyle's Law

### ▶ Jacques Charles

- ▶ The Kelvin Scale; V and T  
Charles' Law

### Joseph Gay-Lussac

- ▶ The composition of water; T and P  
Gay-Lussac's Law



## Combining the Gas Laws

### ▶ The Combined Gas Law

## ▶ Ideal Gas Theory

- ▶ Atomic Theory
  - ▶ What is an ideal gas?

### ▶ Avogadro's Law

### ▶ Ideal Gas Law

- ▶ The Ideal Gas Constant (R)
- ▶ Molar Volume / Gas Stoichiometry
- ▶ Gas Density
- ▶ Molar Mass

## ▶ Gas Mixtures

- ▶ Dalton's Law of Partial Pressures
  - ▶ Mole Fraction

- ▶ Capturing Gases in the Lab
  - ▶ Vapors & Vapor Pressure

## ▶ Real Gases

- ▶ Non-ideal conditions

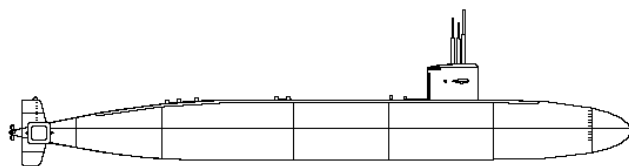
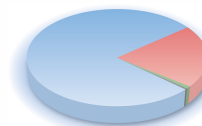
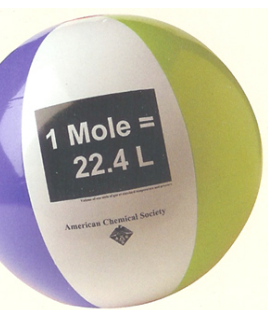

# Deriving the Combined Gas Law

Combining Boyle's Law, Charles' Law and Gay-Lussac's Law into a single relationship...

$$PV = k_x \quad \frac{V}{T} = k_y \quad \frac{P}{T} = k_z$$

$$PV \times \left(\frac{V}{T}\right) \times \left(\frac{P}{T}\right) = k_x \times k_y \times k_z$$

$$\frac{P^2V^2}{T^2} = k_x \times k_y \times k_z$$

$$\left(\frac{PV}{T}\right)^2 = k_x \times k_y \times k_z$$

$$\frac{PV}{T} = \sqrt{k_x \times k_y \times k_z} = k$$

The Combined Gas Law

$$\frac{PV}{T} = k$$

The square root of a bunch of constants is ... just another constant.



# The Combined Gas Law

- ▶ All the previous gas laws allowed us to change two properties of a gas while holding the third constant.
- ▶ With the combined gas law we can explore what happens when three properties change at once.
- ▶ It's more complicated, two of those properties could be having an opposite effect on the third.
- ▶ The results are not as predictable.
- ▶ Which makes the combined gas law so useful.

The Combined Gas Law

$$\frac{PV}{T} = k$$

$$T \uparrow \quad V \uparrow \quad P \quad ?$$

$$P \uparrow \quad T \downarrow \quad V \quad ?$$

$$\frac{P_B V_B}{T_B} = \frac{P_A V_A}{T_A}$$

## Boyle's Law Problem

If you fill a balloon at 298 K and 1.0 atm to 32.5 L and it rises to a height where the pressure is 0.80 atm and the temperature drops to 263 K, what would the balloon's volume become?

Combined Gas Law

$$\frac{P_B V_B}{T_B} = \frac{P_A V_A}{T_A}$$

$$V_A = \frac{T_A}{T_B} \times \frac{P_B}{P_A} \times V_B$$

$$= \frac{298\text{K}}{263\text{K}} \times \frac{1.0\text{ atm}}{0.80\text{ atm}} \times 32.5\text{L}$$

$$= 46.0313688\text{ L}$$

$$= \boxed{46\text{ L}}$$



Temperature must  
be in Kelvin!

# The Gas Laws

Law	Relates	Held Constant	Equation
Boyle's Law	P, V	T, n	$PV = k_T ; P_1 V_1 = P_2 V_2$
Charle's Law	V, T	P, n	$\frac{V}{T} = k_p ; \frac{V_1}{T_1} = \frac{V_2}{T_2}$
Gay-Lussac's Law	T, P	V, n	$\frac{P}{T} = k_v ; \frac{P_1}{T_1} = \frac{P_2}{T_2}$
Combined Gas Law	P, V, T	n	$\frac{PV}{T} = k_n ; \frac{P_1 V_1}{T_1} = \frac{P_2 V_2}{T_2}$

# Gas State of Matter

## ▶ Gas State

- ▶ What's unique about gases?
- ▶ Measuring those properties (V,T,n)

## ▶ Pressure

- ▶ What is pressure (P)?
  - ▶ Standard Temp. & Pressure (STP)
- ▶ Instruments and units of pressure.

## ▶ The Simple Gas Laws

### ▶ Robert Boyle

- ▶ Scientific Method; P and V;  
Boyle's Law

### ▶ Jacques Charles

- ▶ The Kelvin Scale; V and T  
Charles' Law

### Joseph Gay-Lussac

- ▶ The composition of water; T and P  
Gay-Lussac's Law



## ▶ Combining the Gas Laws

- ▶ The Combined Gas Law

## Ideal Gas Theory

### ▶ Atomic Theory

- ▶ What is an ideal gas?

### ▶ Avogadro's Law

### ▶ Ideal Gas Law

- ▶ The Ideal Gas Constant (R)
- ▶ Molar Volume / Gas Stoichiometry
- ▶ Gas Density
- ▶ Molar Mass

## ▶ Gas Mixtures

### ▶ Dalton's Law of Partial Pressures

- ▶ Mole Fraction

### ▶ Capturing Gases in the Lab

- ▶ Vapors & Vapor Pressure

## ▶ Real Gases

- ▶ Non-ideal conditions

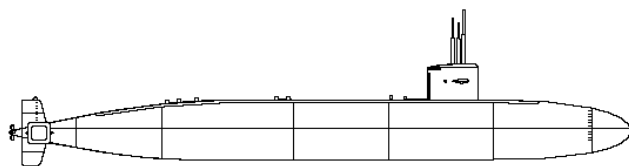
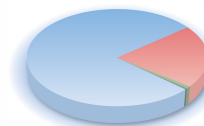
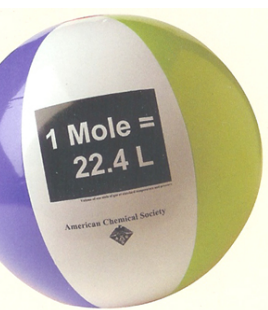



# Laws don't offer explanations.

- ▶ All of this work was established empirically, and produced reliable and fundamental natural laws.
- ▶ But laws aren't explanations.
- ▶ They tell us what we can expect, based on all the observations mankind has made, but they are not theories.
- ▶ Science needs theories, models that explain why observations and the laws that summarize them occur, to advance.
- ▶ The explanation of the gas laws came with atomic theory.

# Atomic Theory Explains the Gas Laws

- ▶ Chemists made observations about P, V, and T of substances in the gas state, they combined those observations into the Gas Laws.
- ▶ John Dalton asked chemists to think of substances as collections of atoms and molecules. Dalton's atomic theory provides an explanation for the behavior observed in the gas laws.
- ▶ We add to Dalton's theory three postulates to refine that theory for gas.
- ▶ **Kinetic Molecular Theory (KMT)** is atomic theory with three additional postulates...
  1. The combined volume of all the molecules is negligible relative to the total volume of the gas.
  2. The *average* kinetic energy of the molecules is proportional to the absolute temperature.
  3. All collisions are completely elastic.
    - ▶ Particles may exchange energy during collisions, but no energy is lost.
    - ▶ This means a gas will never slow down on its own.

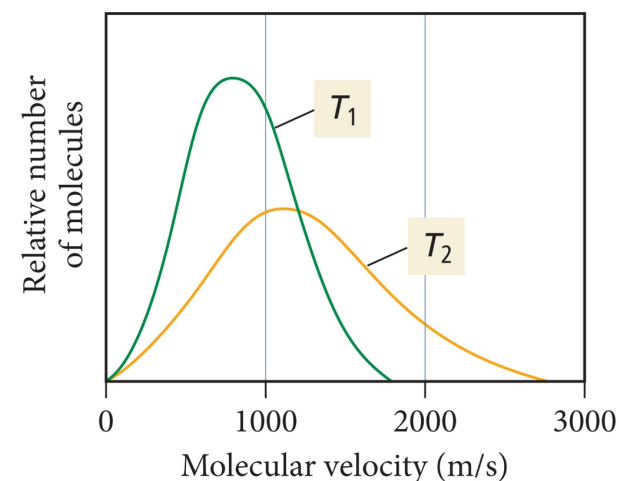

As gases get hotter, the **average** speed of each particle gets faster.

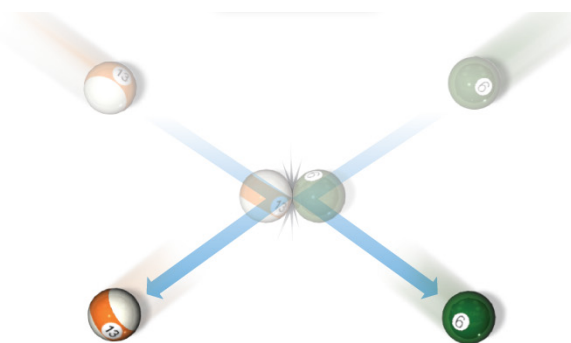

Molecules are more like perfect billiard balls rather than clumps of clay. When they collide, the energy going into a collision comes back out.

At STP the volume of all the molecules of argon combined add up to only 0.01% of the space the gas occupies.

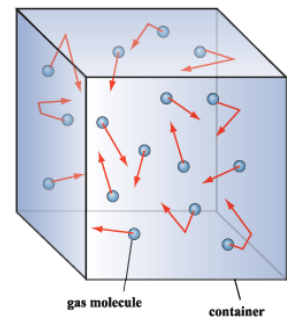

# KMT Explains the Gas Laws

- ▶ **Boyle's Law** states that as **volume increases**, **pressure decreases** (if temperature and number of moles stays the same).
  - ▶ **KMT Explains:**
    - ▶ Pressure is force per unit area. As volume increases, the total container area increases. The collisions per unit area necessary decreases resulting in decreased pressure.

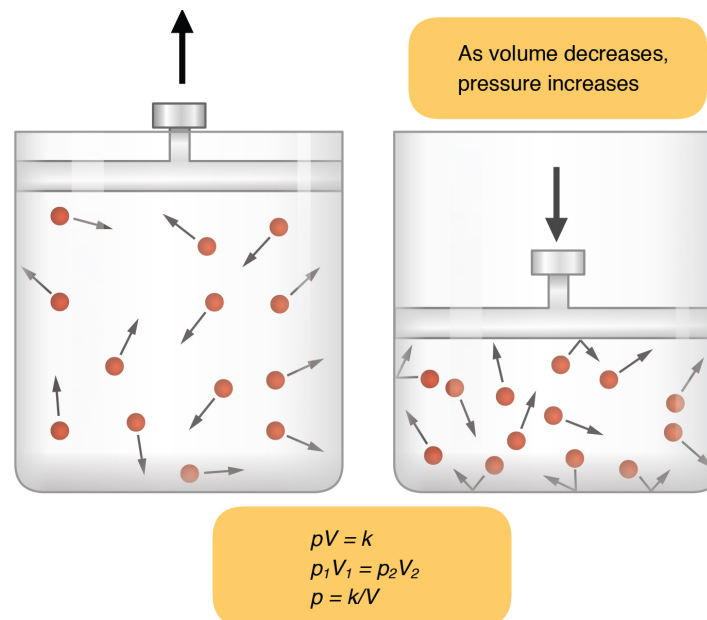

# KMT Explains the Gas Laws

- ▶ Charles' Law states temperature increases, volume increases (if pressure and number of moles stays the same).
  - ▶ KMT Explains:
    - ▶ Temperature relates to the average kinetic energy of the particles. As temperature increases, each particle moves faster and hits harder. Imagine a circus tent full of professional baseball players throwing balls at the tent to keep it supported. If they began throwing faster and harder, the tent would expand to a greater volume.

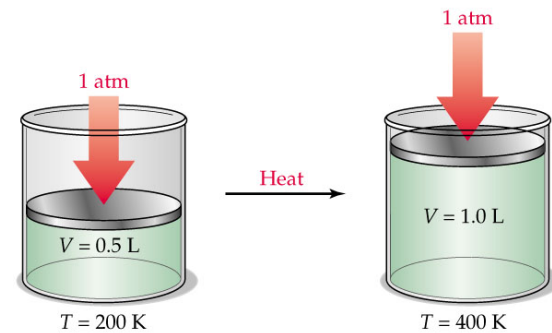
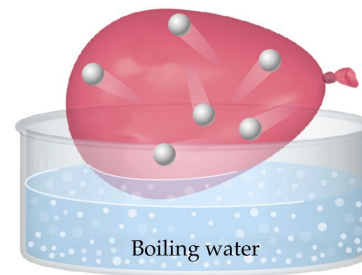
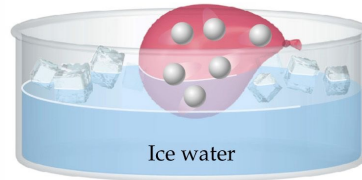
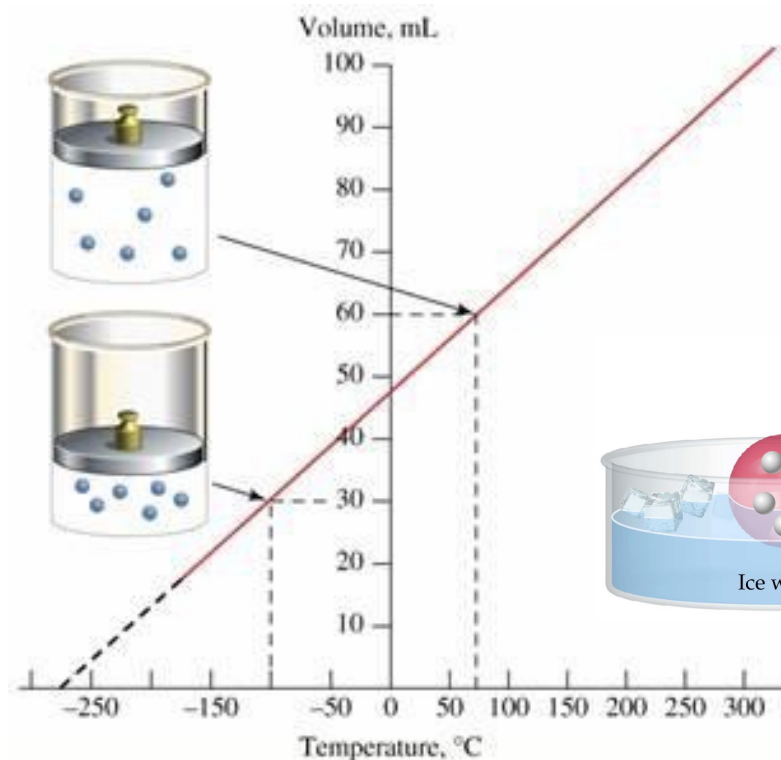



# Ideal Gases

- ▶ A gas that obeys the postulates of KMT perfectly is an **ideal gas**.
- ▶ The postulates of KMT are mostly true. But there are some small deviations. For now we're not going to worry about those differences.
- ▶ Real gases are not ideal gases, but they behave so closely to the ideal gas model that the ideal gas model is a valuable model to predict the behavior of real gases.



# Gas State of Matter

- ▶ Gas State
  - ▶ What's unique about gases?
  - ▶ Measuring those properties (V,T,n)
- ▶ Pressure
  - ▶ What is pressure (P)?
    - ▶ Standard Temp. & Pressure (STP)
  - ▶ Instruments and units of pressure.
- ▶ The Simple Gas Laws
  - ▶ Robert Boyle
    - ▶ Scientific Method; P and V; Boyle's Law
  - ▶ Jacques Charles
    - ▶ The Kelvin Scale; V and T Charles' Law
  - ▶ Joseph Gay-Lussac
    - ▶ The composition of water; T and P Gay-Lussac's Law
- ▶ Combining the Gas Laws
  - ▶ The Combined Gas Law
- ▶ Ideal Gas Theory
  - ▶ Atomic Theory
    - ▶ What is an ideal gas?
  - ▶ Avogadro's Law
  - ▶ Ideal Gas Law
    - ▶ The Ideal Gas Constant (R)
    - ▶ Molar Volume / Gas Stoichiometry
    - ▶ Gas Density
    - ▶ Molar Mass
- ▶ Gas Mixtures
  - ▶ Dalton's Law of Partial Pressures
    - ▶ Mole Fraction
  - ▶ Capturing Gases in the Lab
    - ▶ Vapors & Vapor Pressure
- ▶ Real Gases
  - ▶ Non-ideal conditions

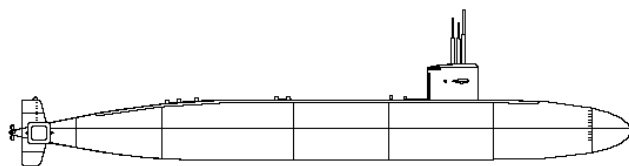
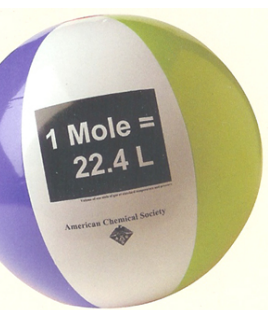
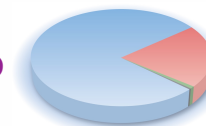

# The Gas Laws

Law	Relates	Held Constant	Equation
Boyle's Law	P, V	T, n	$PV = k_T ; P_1 V_1 = P_2 V_2$
Charle's Law	V, T	P, n	$\frac{V}{T} = k_p ; \frac{V_1}{T_1} = \frac{V_2}{T_2}$
Gay-Lussac's Law	T, P	V, n	$\frac{P}{T} = k_v ; \frac{P_1}{T_1} = \frac{P_2}{T_2}$
Combined Gas Law	P, V, T	n	$\frac{PV}{T} = k_n ; \frac{P_1 V_1}{T_1} = \frac{P_2 V_2}{T_2}$

# Amedeo Avogadro

- ▶ Lorenzo Romano Amedeo Carlo Avogadro was an Italian chemist who lived from 1776-1856.
- ▶ Avogadro made many contributions to understanding the atomic nature of matter and the relative masses of the elements.
- ▶ In honor of his contributions, the value of one of the seven base SI units (the mole) was named after him.
  - ▶ Avogadro's number is the count of single particles in a mole of any substance.
- ▶ Avogadro's research into gases, demonstrating that they are composed of molecules (which are in turn composed of atoms) was fundamental to Dalton's atomic theory.
- ▶ We understand the difference between an atom and a molecule today largely because of Avogadro's work.



Amedeo Avogadro  
1776-1856

$$N_A = 6.022 \times 10^{23}$$

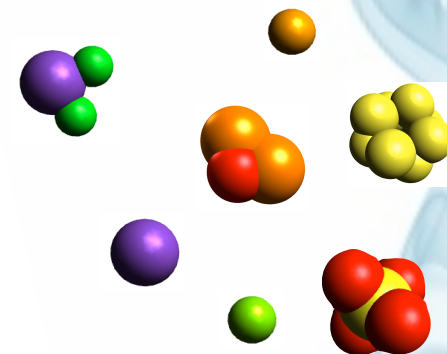



# Amedeo Avogadro

- ▶ Pressure is produced by gas molecules colliding with the walls of a container.
- ▶ At any given temperature and volume, the number of collisions depends on the number of gas molecules present.
- ▶ The number of collisions is directly proportional to the number of gas molecules present.

$V \uparrow$     $n \uparrow$   
 $V \downarrow$     $n \downarrow$

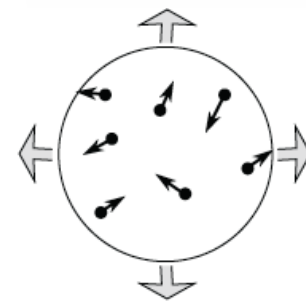
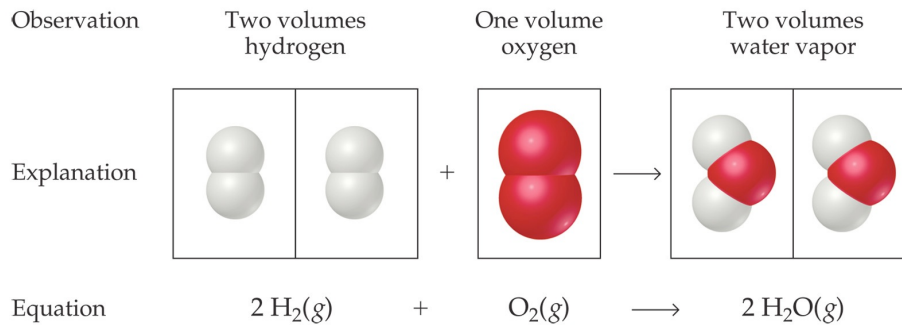
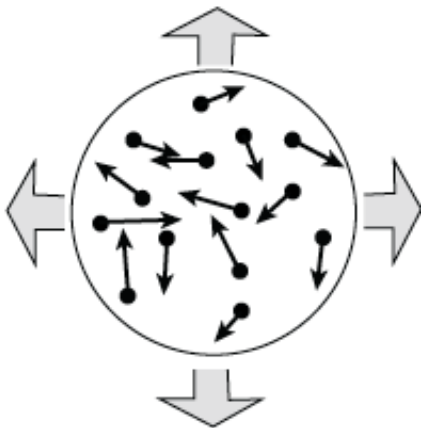

# Avogadro's Law

- ▶ Amedeo Avogadro observed that equal volumes of different gases at the same temperature and pressure contain the same number of molecules.
  - ▶ Two one liter balloons have more molecules in them than a single one.
  - ▶ They have twice as many molecules.
  - ▶ The count of molecules in a gas are directly proportional to the volume of the gas (at constant T and P).
- ▶ This is Avogadro's Law.

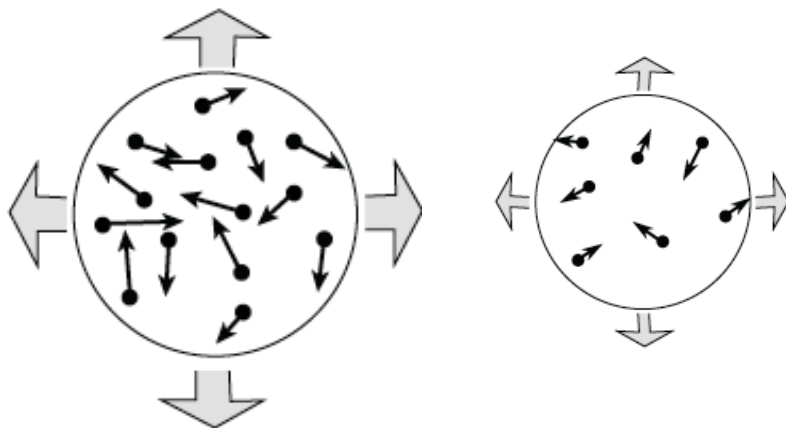

Avogadro's Law:

$$\frac{V}{n} = k$$

$$\frac{V_B}{n_B} = \frac{V_A}{n_A}$$

## Avogadro's Law Problem

A swimmer has a maximum lung capacity of 6.15 L. At this volume his lungs are found to hold 0.254 moles of air. When he exhales his capacity compresses to 2.55 L.

How many moles of air does his lungs hold when he exhales?

### Solution

$$V_1 = 6.15 \text{ L}$$

$$V_2 = 2.55 \text{ L}$$

$$n_1 = 0.254 \text{ moles}$$

$$n_2 = ?$$

$$\frac{V_1}{n_1} = \frac{V_2}{n_2} \quad ; \quad n_2 = \frac{V_2}{V_1} n_1$$

$$n_2 = \frac{V_2}{V_1} n_1 = \frac{2.55 \text{ L}}{6.15 \text{ L}} \cdot 0.254 \text{ moles} = 0.1053171 \text{ moles}$$

$$\boxed{0.105 \text{ moles}}$$

# Gas State of Matter

- ▶ Gas State
  - ▶ What's unique about gases?
  - ▶ Measuring those properties (V,T,n)
- ▶ Pressure
  - ▶ What is pressure (P)?
    - ▶ Standard Temp. & Pressure (STP)
  - ▶ Instruments and units of pressure.
- ▶ The Simple Gas Laws
  - ▶ Robert Boyle
    - ▶ Scientific Method; P and V; Boyle's Law
  - ▶ Jacques Charles
    - ▶ The Kelvin Scale; V and T Charles' Law
  - ▶ Joseph Gay-Lussac
    - ▶ The composition of water; T and P Gay-Lussac's Law
- ▶ Combining the Gas Laws
  - ▶ The Combined Gas Law
- ▶ Ideal Gas Theory
  - ▶ Atomic Theory
    - ▶ What is an ideal gas?
  - ▶ Avogadro's Law
    - ▶ Ideal Gas Law
      - ▶ The Ideal Gas Constant (R)
      - ▶ Molar Volume / Gas Stoichiometry
      - ▶ Gas Density
      - ▶ Molar Mass
- ▶ Gas Mixtures
  - ▶ Dalton's Law of Partial Pressures
    - ▶ Mole Fraction
  - ▶ Capturing Gases in the Lab
    - ▶ Vapors & Vapor Pressure
- ▶ Real Gases
  - ▶ Non-ideal conditions

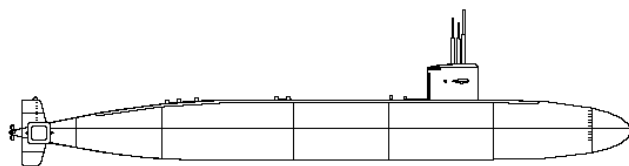
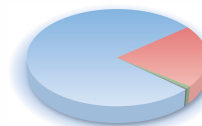
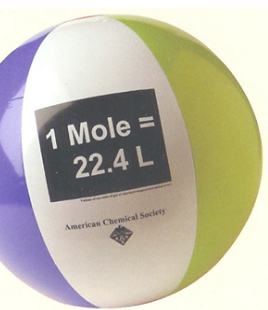



# The Gas Laws

Law	Relates	Held Constant	Equation
Boyle's Law	P, V	T, n	$PV = k_T ; P_1 V_1 = P_2 V_2$
Charle's Law	V, T	P, n	$\frac{V}{T} = k_p ; \frac{V_1}{T_1} = \frac{V_2}{T_2}$
Gay-Lussac's Law	T, P	V, n	$\frac{P}{T} = k_v ; \frac{P_1}{T_1} = \frac{P_2}{T_2}$
Combined Gas Law	P, V, T	n	$\frac{PV}{T} = k_n ; \frac{P_1 V_1}{T_1} = \frac{P_2 V_2}{T_2}$
Avogadro's Law	V, n	T, P	$\frac{V}{n} = k_z ; \frac{V_1}{n_1} = \frac{V_2}{n_2}$

# The Ideal Gas Law

Combining Gay-Lussac's Law and Avogadro's Law into a single relationship...

$$\frac{P}{T} = k_x \quad \frac{V}{n} = k_z$$

$$\left(\frac{P}{T}\right) \times \left(\frac{V}{n}\right) = k_x \times k_z$$

$$\frac{PV}{nT} = k$$

$$k = 0.0821 \frac{\text{L atm}}{\text{mol K}}$$

Unlike all the other gas constants we've talked about  
this  $k$  never changes!

You should know this  
universal constant.

$$0.0821 \frac{\text{L atm}}{\text{mol K}} = R$$

(called the ideal gas constant)

$$PV = nRT$$

The Ideal Gas Law

# The Gas Laws

Law	Relates	Held Constant	Equation
Boyle's Law	P, V	T, n	$PV = k_T ; P_1 V_1 = P_2 V_2$
Charle's Law	V, T	P, n	$\frac{V}{T} = k_p ; \frac{V_1}{T_1} = \frac{V_2}{T_2}$
Gay-Lussac's Law	T, P	V, n	$\frac{P}{T} = k_v ; \frac{P_1}{T_1} = \frac{P_2}{T_2}$
Combined Gas Law	P, V, T	n	$\frac{PV}{T} = k_n ; \frac{P_1 V_1}{T_1} = \frac{P_2 V_2}{T_2}$
Avogadro's Law	V, n	T, P	$\frac{V}{n} = k_z ; \frac{V_1}{n_1} = \frac{V_2}{n_2}$
Ideal Gas Law	P, V, n, T	<i>Nothing!</i>	$PV = nRT$

# The Ideal Gas Law

- ▶ With the ideal gas law, we don't need initial conditions to find the  $k$  of our system.
- ▶  $R$  is a universal constant, as long as dedicate a few brain cells to remember it we can predict any of the properties of any ideal gas, given the other three.
- ▶ That's powerful stuff.

$$PV = nRT$$

The Ideal Gas Law

$$0.0821 \frac{\text{L atm}}{\text{mol K}} = R$$

(called the ideal gas constant)



# You don't need a before...

to use the ideal gas law

- You charge a canister with 3.18 atm of methane gas at room temperature (25°C) and put it in a freezer at -52°C. What's the pressure in the container?

$$T_B = \frac{25^\circ\text{C}}{273.15} + 298\text{ K}$$

(Boyle's Law)

$$\frac{P_B}{T_B} = \frac{P_A}{T_A}$$

$$T_A = \frac{-52^\circ\text{C}}{273.15} + 221\text{ K}$$

$$P_A = \frac{P_B}{T_B} T_A = 3.18\text{ atm} \frac{221\text{ K}}{298\text{ K}} = \underline{2.36\text{ atm}}$$

$$PV = nRT$$

$$0.0821 \frac{\text{L atm}}{\text{mol K}} = R$$

(called the ideal gas constant)

- Someone else finds the container. He has no idea what you did, but estimates the volume at 6.0 L and from the weight decides there are 0.78 moles of methane. What's the pressure in the container?

$$PV = nRT$$

$$P = \frac{nRT}{V} = \frac{(0.78\text{ mol}) (0.0821 \frac{\text{L atm}}{\text{mol K}}) (221\text{ K})}{6.0\text{ L}}$$

$$= 2.358\text{ atm} = \underline{2.4\text{ atm}}$$

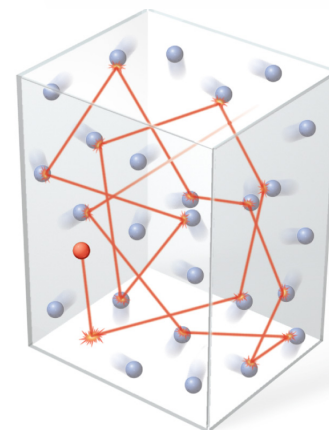

# Rediscovering the Simple Gas Laws

The ideal gas law:  $PV = nRT$

- ▶ The ideal gas law includes all the other gas laws (15+ of them)
- ▶ If you forget the individual law, you can find the law you need:
  - ▶ Solve for the two variables you need.
  - ▶ Roll any other variables that are held constant into R.

$$\frac{PV}{nT} = R \quad \rightarrow$$

$PV = Tn \times R$	$\rightarrow$	$PV = k$	Boyle's Law
$\frac{V}{T} = \frac{n}{P} \times R$	$\rightarrow$	$\frac{V}{T} = k$	Charles' Law
$\frac{V}{n} = \frac{T}{P} \times R$	$\rightarrow$	$\frac{V}{n} = k$	Avogadro's Law
$\frac{P}{T} = \frac{n}{V} \times R$	$\rightarrow$	$\frac{P}{T} = k$	Gay-Lussac's Law

# Gas State of Matter

- ▶ Gas State
  - ▶ What's unique about gases?
  - ▶ Measuring those properties (V,T,n)
- ▶ Pressure
  - ▶ What is pressure (P)?
    - ▶ Standard Temp. & Pressure (STP)
  - ▶ Instruments and units of pressure.
- ▶ The Simple Gas Laws
  - ▶ Robert Boyle
    - ▶ Scientific Method; P and V; Boyle's Law
  - ▶ Jacques Charles
    - ▶ The Kelvin Scale; V and T Charles' Law
  - ▶ Joseph Gay-Lussac
    - ▶ The composition of water; T and P Gay-Lussac's Law
- ▶ Combining the Gas Laws
  - ▶ The Combined Gas Law
- ▶ Ideal Gas Theory
  - ▶ Atomic Theory
    - ▶ What is an ideal gas?
  - ▶ Avogadro's Law
  - ▶ Ideal Gas Law
    - ▶ The Ideal Gas Constant (R)
  - ▶ Molar Volume / Gas Stoichiometry
  - ▶ Gas Density
  - ▶ Molar Mass
- ▶ Gas Mixtures
  - ▶ Dalton's Law of Partial Pressures
    - ▶ Mole Fraction
  - ▶ Capturing Gases in the Lab
    - ▶ Vapors & Vapor Pressure
- ▶ Real Gases
  - ▶ Non-ideal conditions

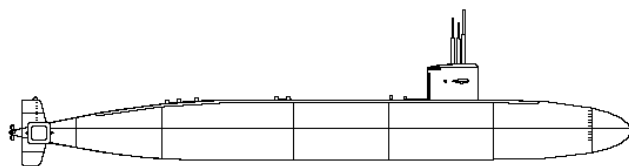
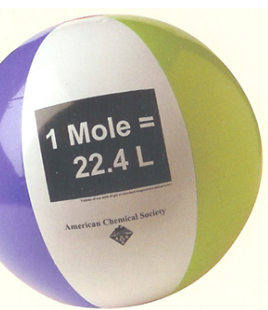
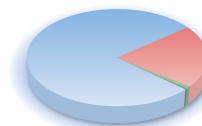

# Molar Volume

- ▶ Avogadro's Law states that:
  - ▶ At a constant temperature and pressure, there is a direct relationship between number of moles and volume.
  - ▶ Regardless of the substance.
- ▶ At standard temperature and pressure (STP) what is volume of 1 mol of any gas? We call this the **molar volume**.



$$PV = nRT$$

STP means  
exactly 1 atm  
exactly 0°C.

$$PV = nRT$$

$$V = \frac{nRT}{P}$$

$$= \frac{(\text{exactly } 1 \text{ mol}) \left(0.0821 \frac{\text{L atm}}{\text{mol} \cdot \text{K}}\right) (-273.15 \text{ K})}{(\text{exactly } 1 \text{ atm})}$$

$$= 22.425615 \text{ L}$$

$$\boxed{22.4 \text{ L}}$$

$$\begin{array}{r} 0.00 \text{ } ^\circ\text{C} \\ + 273.15 \\ \hline 273.15 \text{ K} \end{array}$$

At STP

exactly 1 mol measures 22.4 L

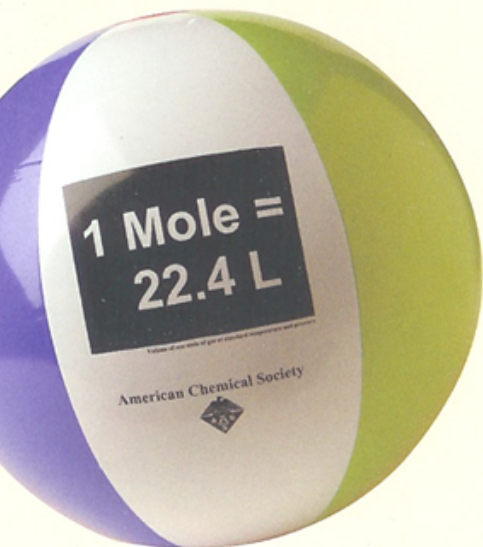



# Molar Volume

Only works at  
STP!

1 mol = 22.4 L at STP  
is the

**Molar Volume**

(of any gas)

One mole of any gas at STP is 22.4 L  
(about the size of a large beach ball)

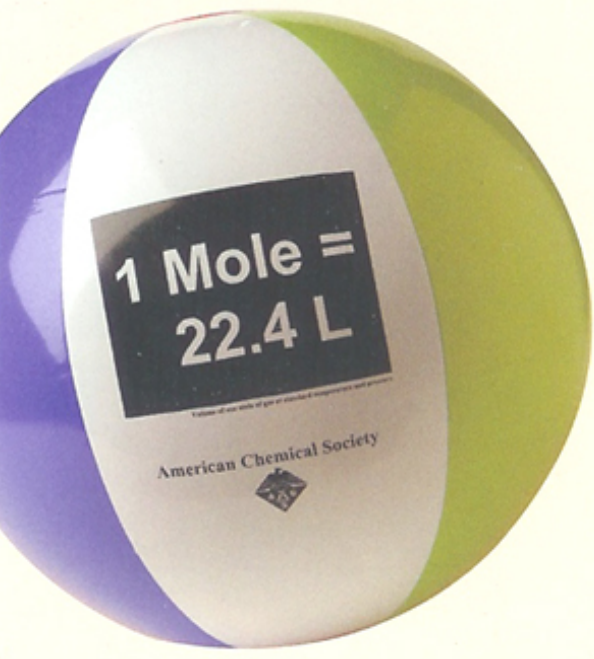

Like molar mass:

- molar volume can be used to find the moles a substance

Unlike molar mass:

- molar volume is the same for every gas
- it depends on temperature and pressure
- it's only 22.4L **at STP**

# Molar Volume

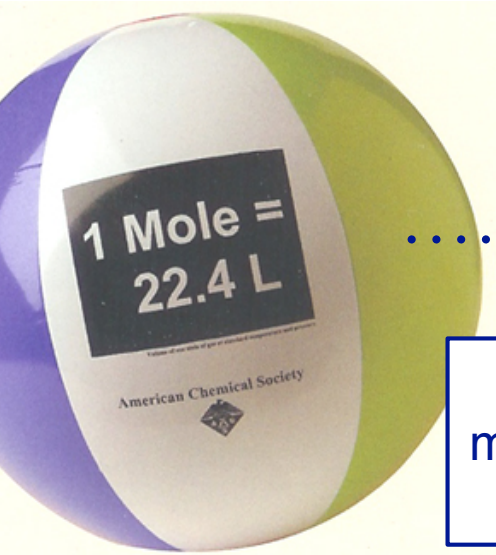
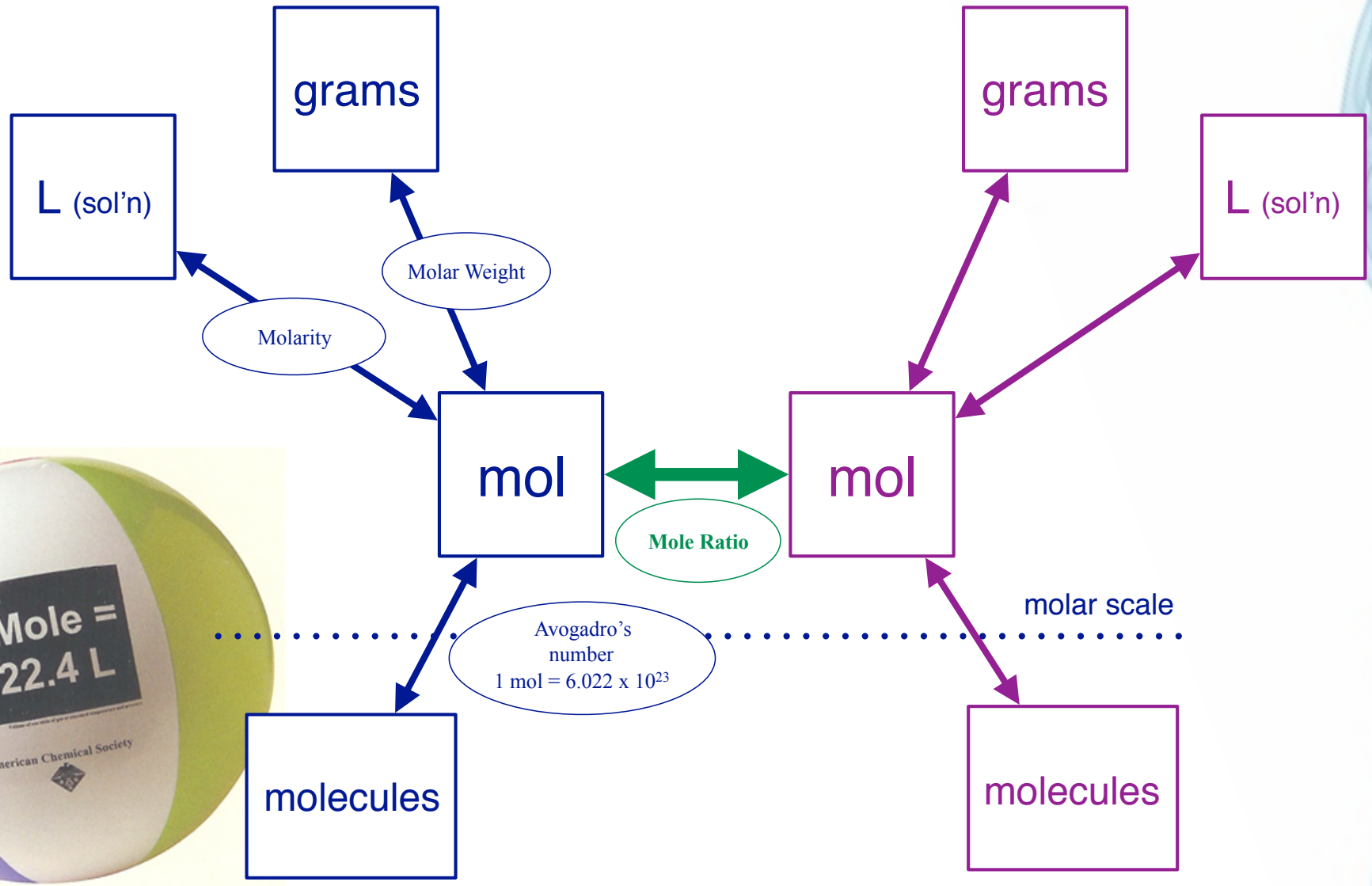

# Molar Volume

Only works at STP!

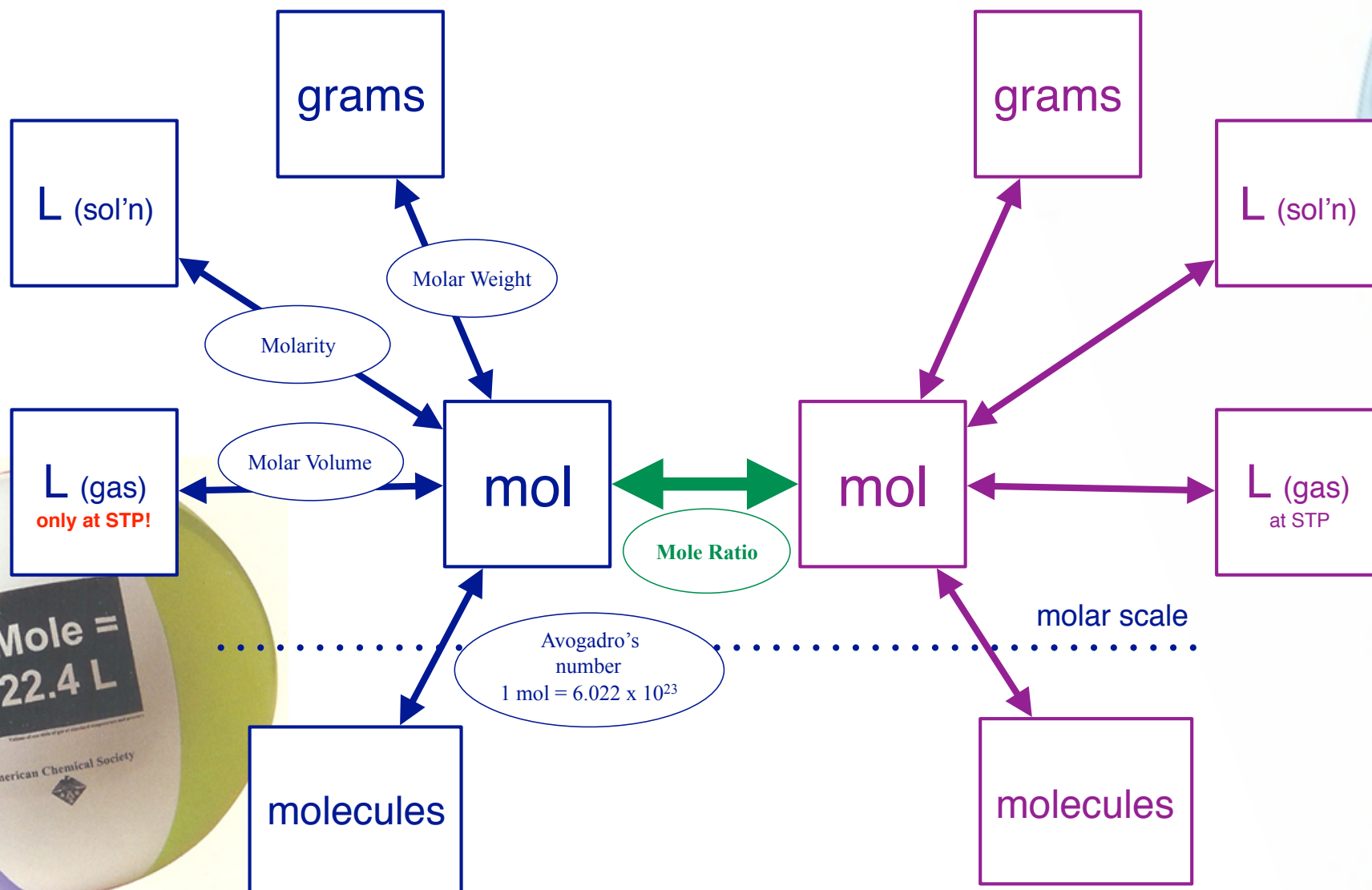

# Molar Volume

Only works at STP!

- ▶ What volume of gas would be produced from 10.4 grams of dry ice ( $\text{CO}_2$ ) at STP?

①  
g → mol → L gas

$$10.4 \text{ g CO}_2 \cdot \frac{1 \text{ mol}}{44.01 \text{ g}} \cdot \frac{22.4 \text{ L}}{1 \text{ mol}} = \boxed{5.29 \text{ L}}$$

$$\begin{array}{r} 10 \\ 20 \\ \hline 44.01 \end{array} = \frac{12.01 \text{ g}}{32.00 \text{ g}} \cdot \frac{44.01 \text{ g/mol}}{44.01 \text{ g/mol}}$$

44.01 g/mol

- ▶ How many molecules are there in 75.6 L of a gas at STP? (doesn't matter what gas)

②  
L gas → mol → molecules

$$75.6 \text{ L} \cdot \frac{1 \text{ mol}}{22.4 \text{ L}} \cdot \frac{6.022 \times 10^{23}}{1 \text{ mol}} = \boxed{2.03 \times 10^{24} \text{ molecules}}$$

- ▶ If 63.5 L of  $\text{H}_2$  gas reacts with excess  $\text{N}_2$  at STP, how many moles of  $\text{NH}_3$  would be produced?

②  
L  $\text{H}_2$  → mol  $\text{H}_2$  → mol  $\text{NH}_3$

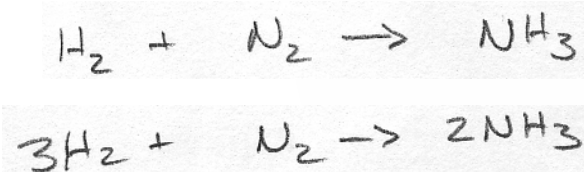

$$63.5 \text{ L} \cdot \frac{1 \text{ mol}}{22.4 \text{ L}} \cdot \frac{2 \text{ NH}_3}{3 \text{ H}_2} = \boxed{1.89 \text{ mol NH}_3}$$





## Problem: Not at STP? Use the Big Gun.

If 25.3 grams of HCl is reacted with excess Na<sub>2</sub>S at 298 K at 1.25 atm, how many liters of H<sub>2</sub>S are formed?

– This is not STP, you cannot use 22.4 L = 1 mol!



25.3 g HCl

$$\begin{array}{r} 35.45 \text{ g} \\ + 1.00 \text{ g} \\ \hline 36.45 \text{ g} \\ 36.46 \text{ g} = 1 \text{ mol} \end{array}$$

$$T = 298 \text{ K}$$

$$P = 1.25 \text{ atm}$$



$$R = .0821 \frac{\text{L atm}}{\text{mol K}}$$

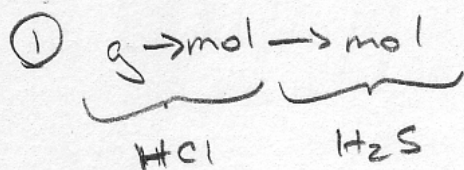

②  $PV = nRT$   
 $V = \frac{nRT}{P}$

$$\textcircled{1} 25.3 \text{ g} \cdot \frac{1 \text{ mol}}{36.46 \text{ g}} \cdot \frac{1 \text{ H}_2\text{S}}{2 \text{ HCl}} = 0.347 \text{ mol}$$

$$\textcircled{2} V = \frac{nRT}{P} = \frac{(0.347 \text{ mol})(0.0821 \frac{\text{L atm}}{\text{mol K}})(298 \text{ K})}{1.25 \text{ atm}} = \underline{\underline{6.79 \text{ L}}}$$

# Gas State of Matter

- ▶ Gas State
  - ▶ What's unique about gases?
  - ▶ Measuring those properties (V,T,n)
- ▶ Pressure
  - ▶ What is pressure (P)?
    - ▶ Standard Temp. & Pressure (STP)
  - ▶ Instruments and units of pressure.
- ▶ The Simple Gas Laws
  - ▶ Robert Boyle
    - ▶ Scientific Method; P and V; Boyle's Law
  - ▶ Jacques Charles
    - ▶ The Kelvin Scale; V and T Charles' Law
  - ▶ Joseph Gay-Lussac
    - ▶ The composition of water; T and P Gay-Lussac's Law
- ▶ Combining the Gas Laws
  - ▶ The Combined Gas Law
- ▶ Ideal Gas Theory
  - ▶ Atomic Theory
    - ▶ What is an ideal gas?
  - ▶ Avogadro's Law
  - ▶ Ideal Gas Law
    - ▶ The Ideal Gas Constant (R)
    - ▶ Molar Volume / Gas Stoichiometry
  - ▶ Gas Density
    - ▶ Molar Mass
- ▶ Gas Mixtures
  - ▶ Dalton's Law of Partial Pressures
    - ▶ Mole Fraction
  - ▶ Capturing Gases in the Lab
    - ▶ Vapors & Vapor Pressure
- ▶ Real Gases
  - ▶ Non-ideal conditions

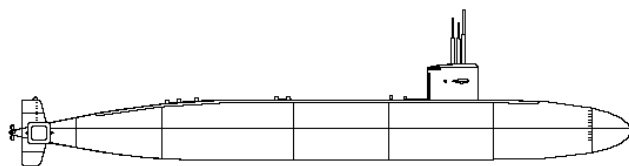
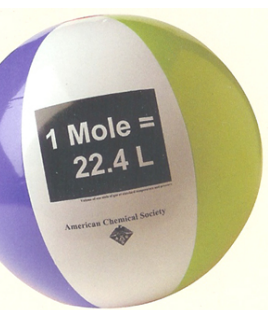
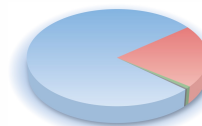

# Gas Density

- ▶ Density is equal to mass over volume.
- ▶ Like liquids, less dense gases float over more dense gases.
- ▶ At STP 1 mol of any gas has a fixed volume of 22.4 L.
- ▶ The periodic table tells you the mass of 1 mol of any substance.
- ▶ So you can always find the density of a gas at STP.

$$\text{Density} = \frac{\text{mass}}{\text{volume}}$$

$$\begin{array}{l} \text{1 mol of He} \\ \text{Density} = \frac{4.00 \text{ g}}{22.4 \text{ L}} = 0.179 \text{ g/L} \\ \text{1 mol of N}_2 \\ \text{Density} = \frac{28.02 \text{ g}}{22.4 \text{ L}} = 1.25 \text{ g/L} \end{array}$$



- ▶ The density of a gas is proportional to its mass.
- ▶ Heavier gases are more dense. Lighter gases are less dense.
- ▶ We can also solve for density at other temperatures & pressures...

$$PV = nRT \quad \frac{RT}{P} = \frac{V}{n} \quad \text{mm} = \frac{\text{mass}}{\text{mol.}} = \frac{\text{mass}}{n}$$

$$\text{density} = \frac{\text{mass}}{\text{volume}} = \frac{\text{mass}/n}{\text{volume}/n} = \frac{\text{molar mass}}{RT/P}$$

$$\begin{array}{l} PV = nRT \\ V/n = RT/P \end{array}$$

- ▶ That gives us two ways to find the density of a gas:

$$d_{\text{STP}} = \frac{\text{mm}}{22.4 \text{ L}} \quad d = \frac{\text{mm} \times P}{RT}$$



# Gas Density

- ▶ What is the density of chlorine gas at STP?

$$\text{Density} = \frac{\text{mass}}{\text{volume}}$$

Assume 1 mol

$$1 \text{ mol Cl}_2 = 70.90 \text{ g}$$

$$1 \text{ mol Cl}_2 = 22.4 \text{ L} \\ \text{at STP}$$

$$d = \frac{\text{mass}}{\text{vol}} = \frac{70.90 \text{ g}}{22.4 \text{ L}} = \boxed{3.17 \text{ g/L}}$$

- ▶ At STP, Air has a density of 1.29 g/L. Will a chlorine filled balloon float in air?

$$3.17 \text{ g/L} > 1.29 \text{ g/L} \quad \therefore \text{Chlorine won't float.}$$

- ▶ What is the density of chlorine gas at 1.2 atm and 26.5 °C?

$$\text{density} = \frac{\text{mass}}{\text{volume}} = \frac{\text{mass}/n}{\text{volume}/n} = \frac{\text{molar mass}}{\left(\frac{RT}{P}\right)}$$

$$\begin{array}{r} 26.5 \text{ } ^\circ\text{C} \\ + 273.15 \\ \hline 299.65 \text{ K} \\ \hline 299.7 \text{ K} \end{array}$$

$$= \frac{70.90 \text{ grams}}{\left(\frac{0.0821 \frac{\text{L atm}}{\text{mol K}} \cdot 299.7 \text{ K}}{1.2 \text{ atm}}\right)}$$

$$= \boxed{3.46 \text{ g/L}}$$



$$\begin{aligned} PV &= nRT \\ V/n &= RT/P \end{aligned}$$



## Finding the density of a gas.

What is the density of oxygen gas at 145 deg Celsius and 855 mm Hg?

$$T = 145^{\circ}\text{C} \quad \begin{array}{r} 145 \\ + 273.15 \\ \hline 418.15 \end{array}$$
$$= 418\text{K}$$

$$P = 855\text{mmHg}$$
$$\times \frac{1\text{atm}}{760\text{mmHg}}$$
$$= 1.13\text{atm}$$

$$R = 0.0821 \frac{\text{L}\cdot\text{atm}}{\text{mol}\cdot\text{K}}$$

$$\textcircled{1} \quad PV = nRT$$
$$\frac{\text{vol}}{n} = \frac{RT}{P}$$

$$\textcircled{2} \quad \frac{\text{mass}}{n} = \text{molar mass}$$

$$\textcircled{3} \quad d = \frac{\text{mass}}{\text{vol}} = \frac{\text{mass}/n}{\text{vol}/n}$$

$$\frac{\text{vol}}{n} = \frac{RT}{P} = \frac{0.0821 \frac{\text{L}\cdot\text{atm}}{\text{mol}\cdot\text{K}} \cdot 418\text{K}}{1.13\text{atm}}$$

$$= 30.36973 \frac{\text{L}}{\text{mol}} = 30.4 \frac{\text{L}}{\text{mol}}$$

$$\frac{\text{mass}}{n} = \text{molar mass}_{\text{O}_2} = 32.00 \text{g/mol}$$

$$d = \frac{\text{mass}}{\text{vol}} = \frac{\text{mass}/n}{\text{vol}/n} = \frac{32.00 \text{g/mol}}{30.4 \text{L/mol}} = \boxed{1.05 \text{g/L}}$$

# Gas State of Matter

- ▶ Gas State
  - ▶ What's unique about gases?
  - ▶ Measuring those properties (V,T,n)
- ▶ Pressure
  - ▶ What is pressure (P)?
    - ▶ Standard Temp. & Pressure (STP)
  - ▶ Instruments and units of pressure.
- ▶ The Simple Gas Laws
  - ▶ Robert Boyle
    - ▶ Scientific Method; P and V; Boyle's Law
  - ▶ Jacques Charles
    - ▶ The Kelvin Scale; V and T Charles' Law
  - ▶ Joseph Gay-Lussac
    - ▶ The composition of water; T and P Gay-Lussac's Law
- ▶ Combining the Gas Laws
  - ▶ The Combined Gas Law
- ▶ Ideal Gas Theory
  - ▶ Atomic Theory
    - ▶ What is an ideal gas?
  - ▶ Avogadro's Law
  - ▶ Ideal Gas Law
    - ▶ The Ideal Gas Constant (R)
    - ▶ Molar Volume / Gas Stoichiometry
    - ▶ Gas Density
    - ▶ Molar Mass
- ▶ Gas Mixtures
  - ▶ Dalton's Law of Partial Pressures
    - ▶ Mole Fraction
  - ▶ Capturing Gases in the Lab
    - ▶ Vapors & Vapor Pressure
- ▶ Real Gases
  - ▶ Non-ideal conditions

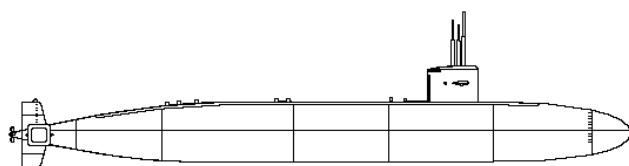
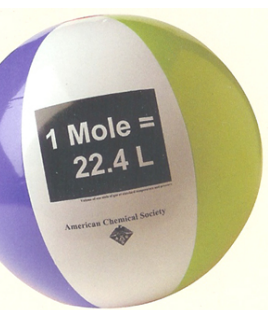
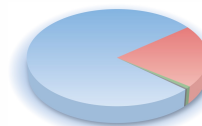

# Solving for Molar Mass

- ▶ The ideal gas law relates moles to P, V, and T.
- ▶ Since we can measure P, V, and T easily, we can calculate moles.
- ▶ We can also measure mass.
- ▶ The ideal gas law is a great way to find the molar mass of a material.

$$PV=nRT$$

$$n = \frac{PV}{RT}$$

$$\text{molar mass} = \frac{\text{grams}}{\text{mol}} = \frac{\text{grams}}{\left( \frac{PV}{RT} \right)}$$

## Problem: Finding Molar Mass

A sample gas has a mass of 0.827 grams. It's put into a 0.270 L container and the pressure and temperature are measured 88°C and 975 mmHg.

What is the molar mass of the unknown? (hint: you are not at STP but know the mass, you just need the moles.)

$$\text{mass} = 0.827 \text{ g}$$

$$\text{vol} = 0.270 \text{ L}$$

$$\text{temp} = \frac{88^\circ \text{C} + 273.15}{361.1} = 361 \text{ K}$$

$$\text{pressure} = 975 \text{ mmHg}$$

$$975 \text{ mmHg} \cdot \frac{1 \text{ atm}}{760 \text{ mmHg}} = 1.28 \text{ atm}$$

$$R = 0.0821 \frac{\text{L atm}}{\text{mol K}}$$

① STD Units    ②  $n = \frac{PV}{RT}$     ③  $\text{mm} = \frac{\text{grams}}{\text{mol}}$

$$n = \frac{PV}{RT} = \frac{(1.28 \text{ atm})(0.270 \text{ L})}{(0.0821 \frac{\text{L atm}}{\text{mol K}})(361 \text{ K})} = 1.17 \times 10^{-2} \text{ mol}$$

$$\text{mm} = \frac{0.827 \text{ g}}{1.17 \times 10^{-2} \text{ mol}} = \boxed{70.7 \text{ g/mol}}$$



# Gas State of Matter

- ▶ Gas State
  - ▶ What's unique about gases?
  - ▶ Measuring those properties (V,T,n)
- ▶ Pressure
  - ▶ What is pressure (P)?
    - ▶ Standard Temp. & Pressure (STP)
  - ▶ Instruments and units of pressure.
- ▶ The Simple Gas Laws
  - ▶ Robert Boyle
    - ▶ Scientific Method; P and V; Boyle's Law
  - ▶ Jacques Charles
    - ▶ The Kelvin Scale; V and T Charles' Law
  - ▶ Joseph Gay-Lussac
    - ▶ The composition of water; T and P Gay-Lussac's Law
- ▶ Combining the Gas Laws
  - ▶ The Combined Gas Law
- ▶ Ideal Gas Theory
  - ▶ Atomic Theory
    - ▶ What is an ideal gas?
  - ▶ Avogadro's Law
  - ▶ Ideal Gas Law
    - ▶ The Ideal Gas Constant (R)
    - ▶ Molar Volume / Gas Stoichiometry
    - ▶ Gas Density
    - ▶ Molar Mass
- ▶ Gas Mixtures
  - ▶ Dalton's Law of Partial Pressures
    - ▶ Mole Fraction
  - ▶ Capturing Gases in the Lab
    - ▶ Vapors & Vapor Pressure
- ▶ Real Gases
  - ▶ Non-ideal conditions

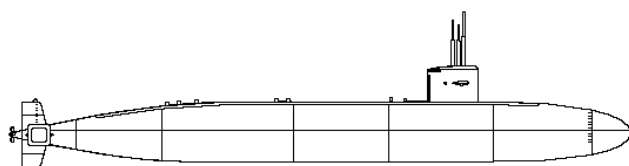
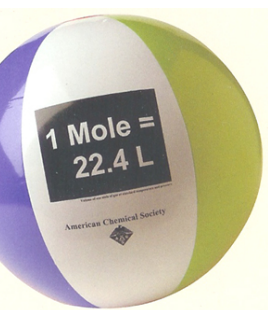
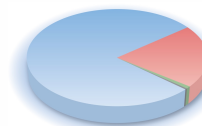

# Gas Mixtures

- ▶ Pressure is caused by particles of a gas striking the walls of its container.
  - ▶ The pressure caused by one gas exerts a pressure.
  - ▶ The pressure caused by a second gas exerts a second pressure.
- ▶ If you mix the two gases, they each exert the same pressure as before.
- ▶ We call the pressure exerted by each individual gas its **partial pressure**.
  - ▶ Each partial pressure acts independently to result in a **total pressure** for the system.
- ▶ You can predict the total pressure of the gas mixture by adding the partial pressures of each gas.

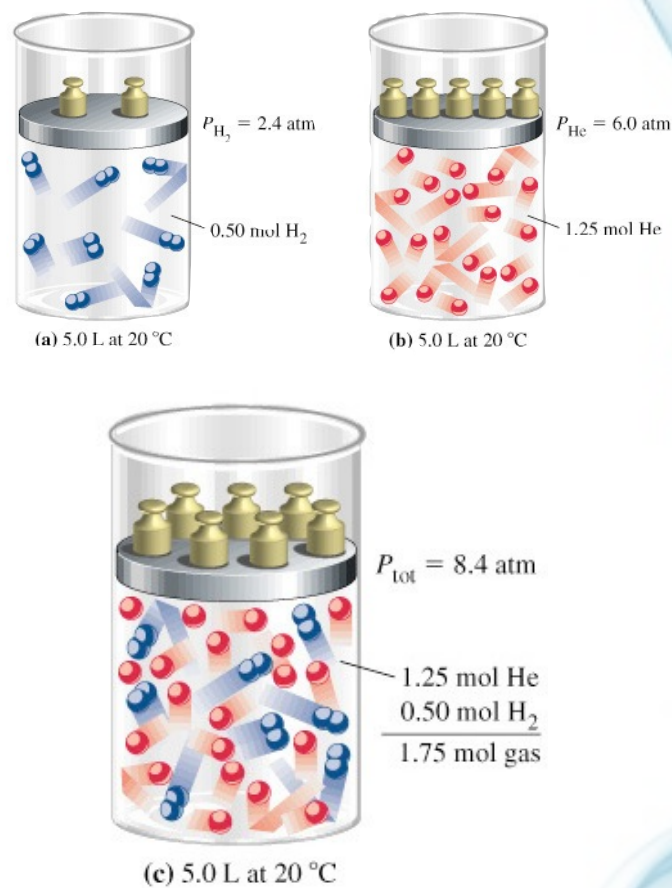

# Dalton's Law of Partial Pressures

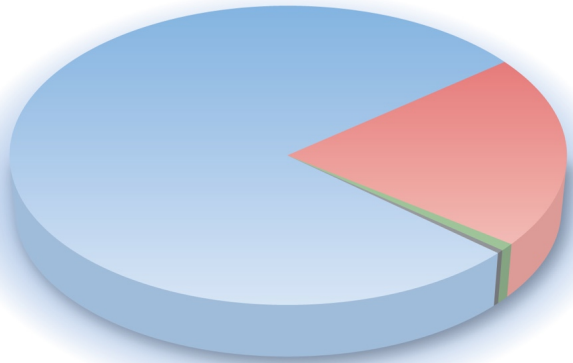

78%  $\text{N}_2$     21%  $\text{O}_2$   
0.9%  $\text{Ar}$     0.04%  $\text{CO}_2$

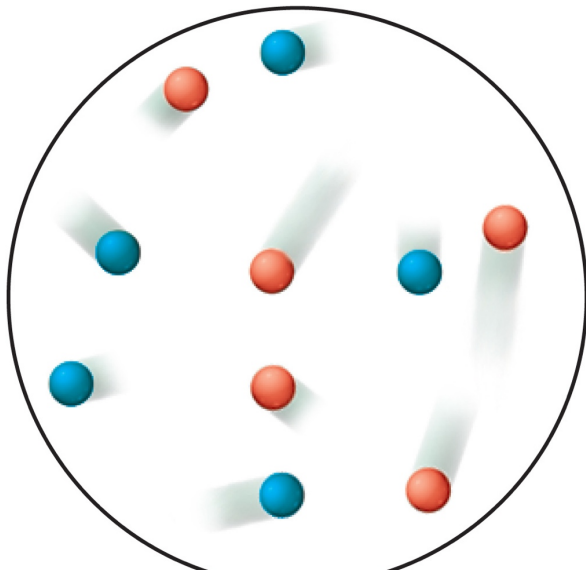

$$P_{\text{total}} = n_{\text{total}} RT/V$$

$$n_{\text{total}} = n_{\text{N}_2} + n_{\text{O}_2} + n_{\text{Ar}} + n_{\text{CO}_2}$$

$$P_{\text{total}} = (n_{\text{N}_2} + n_{\text{O}_2} + n_{\text{Ar}} + n_{\text{CO}_2}) RT/V$$

$$P_{\text{total}} = n_{\text{N}_2}(RT/V) + n_{\text{O}_2}(RT/V) + n_{\text{Ar}}(RT/V) + n_{\text{CO}_2}(RT/V)$$

$$P_{\text{total}} = P_{\text{N}_2} + P_{\text{O}_2} + P_{\text{Ar}} + P_{\text{CO}_2}$$

Dalton's Law of Partial Pressures

# The Mole Fraction

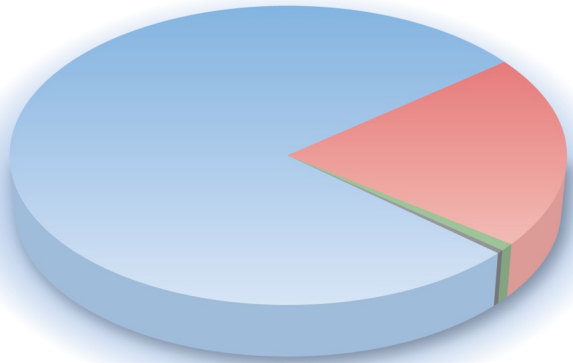

78% ■ N<sub>2</sub>      21% ■ O<sub>2</sub>  
0.9% ■ Ar      0.04% ■ CO<sub>2</sub>

$$\frac{P_{N_2}}{P_{\text{total}}} = \frac{n_{N_2} \left( \frac{RT}{V} \right)}{n_{\text{total}} \left( \frac{RT}{V} \right)} = \frac{n_{N_2}}{n_{\text{total}}}$$

$$\chi_{n_{N_2}} = \frac{n_{N_2}}{n_{\text{total}}}$$

Mole Fraction

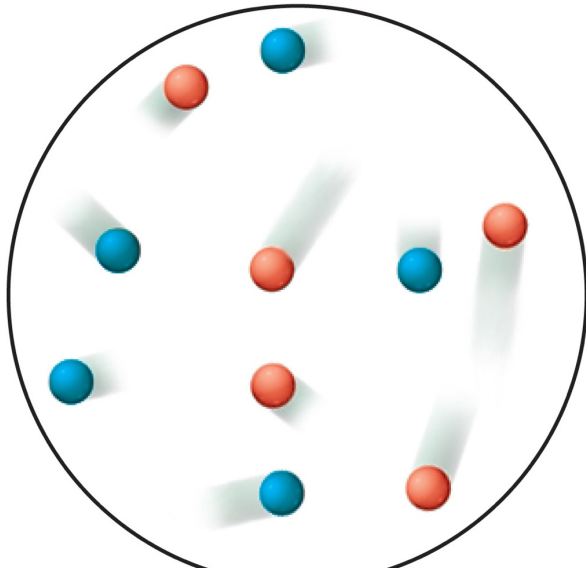

$$P_{\text{total}} \times \chi_{n_{N_2}} = P_{N_2}$$

The mole fraction relates any partial pressure to the total pressure.



# Gas Mixtures

There's been a submarine accident. The sealed hallway between you and the exit is about 27,200 L volume. It's filled with pure helium gas at 22.05 atm pressure.

You estimate it will take you 6 minutes to get through the hallway, you can only hold your breath for 2 minutes.

To breathe you need oxygen pressure of at least 0.16 atm, but more than 1.6 atm of oxygen is poisonous.

- ▶ You find a tank of oxygen under 285 atm pressure. It's volume is 32.0 L. If you open the tank into the 27,200 L hallway what will be the partial pressure of oxygen?

$$P_B V_B = P_A V_A \quad P_A = \frac{P_B V_B}{V_A} = \frac{(285 \text{ atm})(32.0 \text{ L})}{27,200 \text{ L}} = \underline{0.335 \text{ atm}}$$

- ▶ What is the total pressure in the hall after you do? What's the mole fraction of oxygen?

$$P_{\text{TOTAL}} = P_{\text{O}_2} + P_{\text{He}} = \frac{0.335 \text{ atm}}{22.00 \text{ atm}} \cdot 22.3315 \text{ atm} + 22.00 \text{ atm} = \underline{22.34 \text{ atm}}$$

$$X_{\text{O}_2} = \frac{n_{\text{O}_2}}{n_{\text{TOTAL}}} = \frac{P_{\text{O}_2}}{P_{\text{TOTAL}}} = \frac{0.335 \text{ atm}}{22.34 \text{ atm}} = \underline{0.0150}$$

- ▶ If you bleed off gases from the hallway to drop the total pressure to 12.0 atm, what is the new partial pressure of oxygen?

$$P_{\text{O}_2} = X_{\text{O}_2} \cdot P_{\text{TOTAL}} = 0.0150 \cdot 12.0 \text{ atm} = \underline{0.180 \text{ atm}}$$

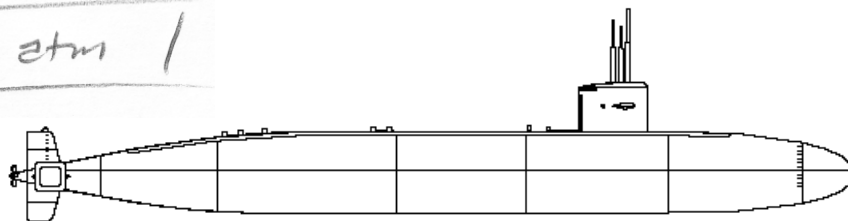

## Problem: Partial Pressures

A 12.5L diving tank contains 24.2 grams of helium and 4.32 grams of oxygen at 298 K.

- What is the mole fraction of each component?
- What is the total pressure of the tank?
- What is the partial pressure of each?

$$V = 12.5L$$
$$T = 298K$$

$$24.2g \text{ He}$$

$$4.32g \text{ O}_2$$

- g  $\rightarrow$  mol of each
- find the mol fraction  $X_A, X_B$
- find total pressure ( $PV = nRT$ )
- find partial pressure  $P_A = X_A P_T$

$$24.2g \text{ He} \cdot \frac{1 \text{ mol}}{4.00g} = 6.05 \text{ mol He}$$
$$4.32g \text{ O}_2 \cdot \frac{1 \text{ mol}}{32.00g} = 0.135 \text{ mol O}_2$$

$$X_{\text{He}} = \frac{6.05 \text{ mol}}{6.05 \text{ mol} + 0.135 \text{ mol}} = 0.978$$
$$X_{\text{O}_2} = \frac{0.135 \text{ mol}}{6.05 \text{ mol} + 0.135 \text{ mol}} = 0.0218$$

$$P_T = \frac{nRT}{V} = \frac{(6.05 \text{ mol} + 0.135 \text{ mol}) \left(0.0821 \frac{\text{L atm}}{\text{mol K}}\right) 298 \text{ K}}{12.5 \text{ L}} = 12.1 \text{ atm}$$

$$P_{\text{He}} = X_{\text{He}} \cdot P_T = 0.978 \cdot 12.1 \text{ atm} = \underline{11.8 \text{ atm}}$$

$$P_{\text{O}_2} = X_{\text{O}_2} \cdot P_T = 0.0218 \cdot 12.1 \text{ atm} = \underline{0.264 \text{ atm}}$$

# Gas State of Matter

- ▶ Gas State
  - ▶ What's unique about gases?
  - ▶ Measuring those properties (V,T,n)
- ▶ Pressure
  - ▶ What is pressure (P)?
    - ▶ Standard Temp. & Pressure (STP)
  - ▶ Instruments and units of pressure.
- ▶ The Simple Gas Laws
  - ▶ Robert Boyle
    - ▶ Scientific Method; P and V; Boyle's Law
  - ▶ Jacques Charles
    - ▶ The Kelvin Scale; V and T Charles' Law
  - ▶ Joseph Gay-Lussac
    - ▶ The composition of water; T and P Gay-Lussac's Law
- ▶ Combining the Gas Laws
  - ▶ The Combined Gas Law
- ▶ Ideal Gas Theory
  - ▶ Atomic Theory
    - ▶ What is an ideal gas?
  - ▶ Avogadro's Law
  - ▶ Ideal Gas Law
    - ▶ The Ideal Gas Constant (R)
    - ▶ Molar Volume / Gas Stoichiometry
    - ▶ Gas Density
    - ▶ Molar Mass
- ▶ Gas Mixtures
  - ▶ Dalton's Law of Partial Pressures
    - ▶ Mole Fraction
- ▶ Capturing Gases in the Lab
  - ▶ Vapors & Vapor Pressure
- ▶ Real Gases
  - ▶ Non-ideal conditions

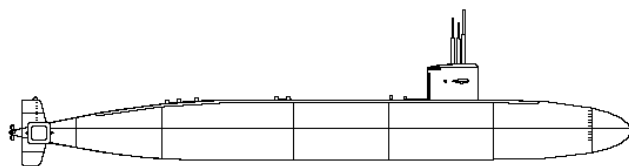
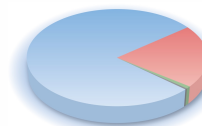
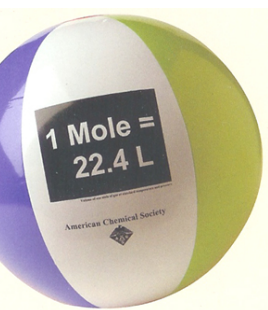

# Vapor Pressure

- ▶ **Vapors** are substances that are in the gas phase below their boiling temperature.
- ▶ Some particles in a liquids move faster than average.
  - ▶ These break free of the surface when they strike it and enter the gas phase.
- ▶ Some particles in the gas phase move slower than average.
  - ▶ These stick to the liquid when they strike it and enter the liquid phase.
- ▶ Eventually this process reaches equilibrium, where a constant pressure of vapor exists over the liquid.
- ▶ The **vapor pressure** of any liquid depends only on the temperature of the liquid.

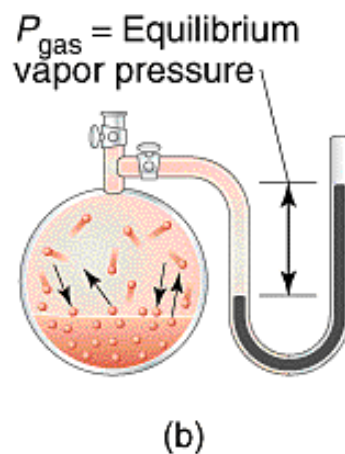
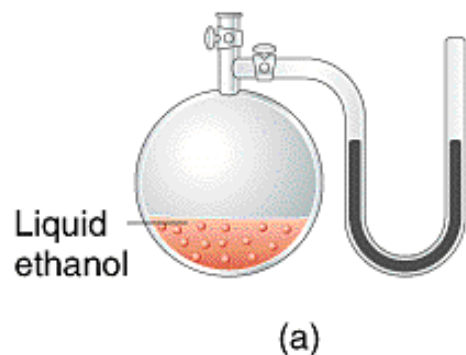

TABLE 5.4 Vapor Pressure of Water versus Temperature

Temperature (°C)	Pressure (mmHg)	Temperature (°C)	Pressure (mmHg)
0	4.58	55	118.2
5	6.54	60	149.6
10	9.21	65	187.5
15	12.79	70	233.7
20	17.55	75	289.1
25	23.78	80	355.1
30	31.86	85	433.6
35	42.23	90	525.8
40	55.40	95	633.9
45	71.97	100	760.0
50	92.6		

© 2014 Pearson Education, Inc.



# Trapping Gas over Water

- ▶ Water traps are an excellent way to capture gases.
- ▶ The **vapor pressure** of water produces a **partial pressure** of water vapor.
- ▶ Measuring the total pressure and temperature, allows you to calculate the partial pressure of the captured gas.

$$P_{\text{total}} = P_{\text{H}_2\text{O}} + P_{\text{H}_2}$$

$$P_{\text{H}_2} = P_{\text{total}} - P_{\text{H}_2\text{O}}$$

- ▶ From the partial pressure, temp, and volume you can calculate the moles collected.

TABLE 5.4 Vapor Pressure of Water versus Temperature

Temperature (°C)	Pressure (mmHg)	Temperature (°C)	Pressure (mmHg)
0	4.58	55	118.2
5	6.54	60	149.6
10	9.21	65	187.5
15	12.79	70	233.7
20	17.55	75	289.1
25	23.78	80	355.1
30	31.86	85	433.6
35	42.23	90	525.8
40	55.40	95	633.9
45	71.97	100	760.0
50	92.6		

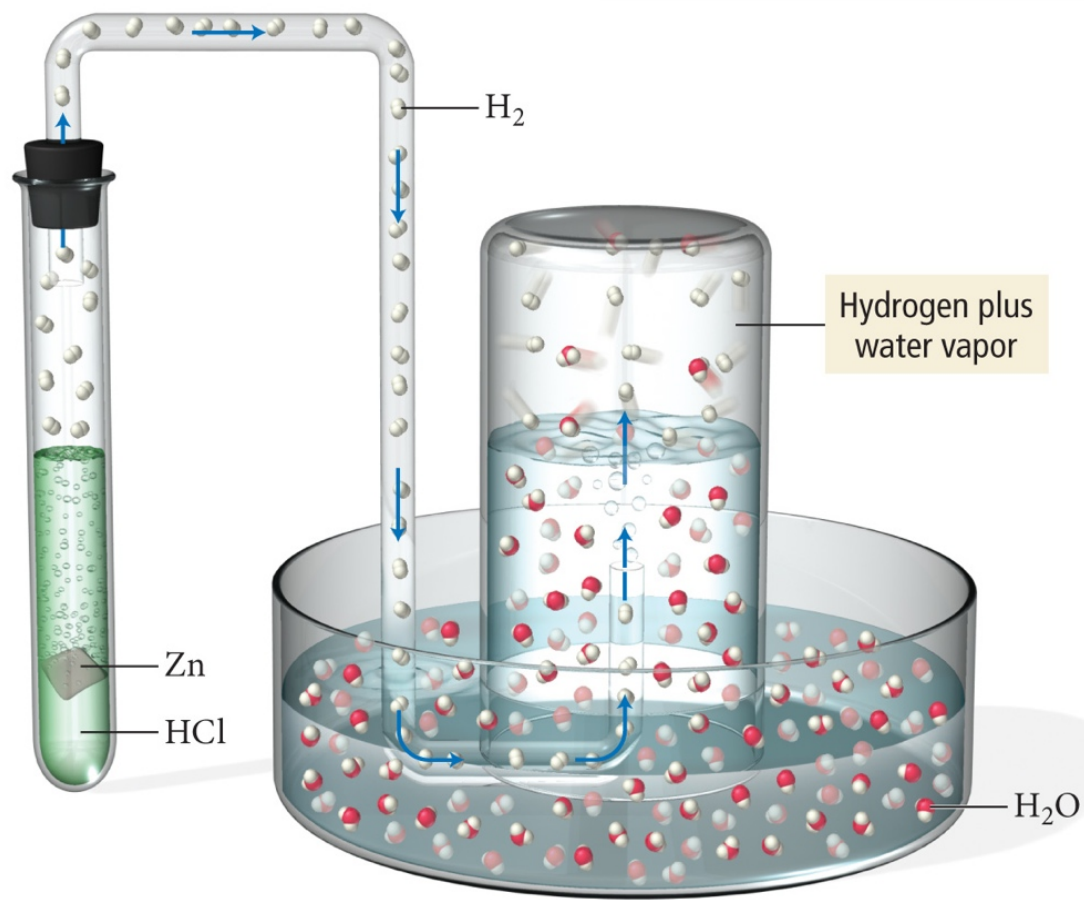

# Problem: Collecting Gas over Water

Hydrogen gas is collected over water at a temperature of 293 K and total pressure of 755.2 mmHg. If 1.35 L of gas is collected, what mass of hydrogen gas is captured?

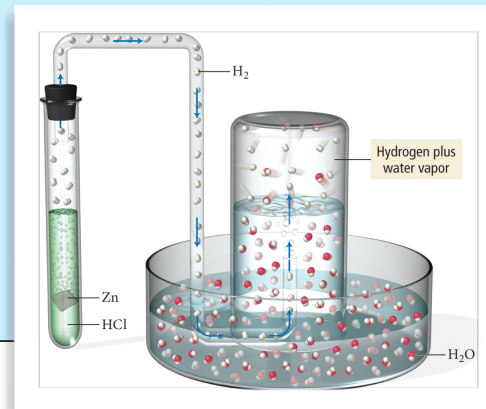

$$T = 293 \text{ K}$$

$$V = 1.35 \text{ L}$$

$$P_{\text{TOTAL}} = 755.2 \text{ mmHg}$$

$$T = 293 \text{ K}$$

$$- 273.15$$

---

$$19.85 \text{ }^\circ\text{C}$$

$$20^\circ\text{C}$$

$$P_{\text{H}_2\text{O}} = 17.55 \text{ mmHg}$$

TABLE 5.4 Vapor Pressure of Water versus Temperature

Temperature (°C)	Pressure (mmHg)	Temperature (°C)	Pressure (mmHg)
0	4.58	55	118.2
5	6.54	60	149.6
10	9.21	65	187.5
15	12.79	70	233.7
20	17.55	75	289.1
25	23.78	80	355.1
30	31.86	85	433.6

- Find the partial pressure of  $\text{H}_2$   
 $P_{\text{TOTAL}} = P_{\text{H}_2} + P_{\text{H}_2\text{O}}$
- Find the moles of  $\text{H}_2$   
 $PV = nRT$
- Find grams  
mol  $\rightarrow$  g

$$\textcircled{1} \quad \begin{array}{r} 755.21 \text{ mmHg} \\ - 17.55 \text{ mmHg} \\ \hline 737.66 \end{array}$$

$$P_{\text{H}_2} = 737.7 \text{ mmHg} \cdot \frac{1 \text{ atm}}{760 \text{ mmHg}} = 0.971 \text{ atm}$$

$$\textcircled{2} \quad PV = nRT$$

$$n = \frac{PV}{RT} = \frac{(0.971 \text{ atm})(1.35 \text{ L})}{(0.0821 \frac{\text{L atm}}{\text{mol K}})(293 \text{ K})} = 0.0545 \text{ mol.}$$

$$\textcircled{3} \quad 0.0545 \text{ mol} \cdot \frac{2.016 \text{ g}}{1 \text{ mol}} = \underline{0.110 \text{ g H}_2}$$

# Gas State of Matter

- ▶ Gas State
  - ▶ What's unique about gases?
  - ▶ Measuring those properties (V,T,n)
- ▶ Pressure
  - ▶ What is pressure (P)?
    - ▶ Standard Temp. & Pressure (STP)
  - ▶ Instruments and units of pressure.
- ▶ The Simple Gas Laws
  - ▶ Robert Boyle
    - ▶ Scientific Method; P and V; Boyle's Law
  - ▶ Jacques Charles
    - ▶ The Kelvin Scale; V and T Charles' Law
  - ▶ Joseph Gay-Lussac
    - ▶ The composition of water; T and P Gay-Lussac's Law
- ▶ Combining the Gas Laws
  - ▶ The Combined Gas Law
- ▶ Ideal Gas Theory
  - ▶ Atomic Theory
    - ▶ What is an ideal gas?
  - ▶ Avogadro's Law
  - ▶ Ideal Gas Law
    - ▶ The Ideal Gas Constant (R)
    - ▶ Molar Volume / Gas Stoichiometry
    - ▶ Gas Density
    - ▶ Molar Mass
- ▶ Gas Mixtures
  - ▶ Dalton's Law of Partial Pressures
    - ▶ Mole Fraction
  - ▶ Capturing Gases in the Lab
    - ▶ Vapors & Vapor Pressure
- ▶ Real Gases
  - ▶ Non-ideal conditions

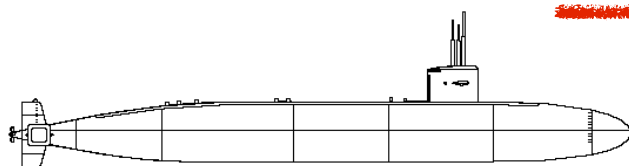
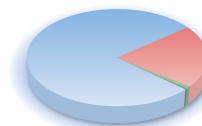
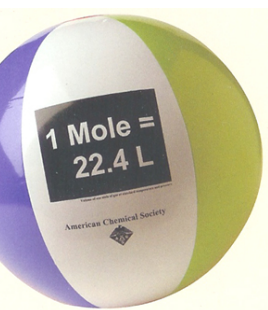

# KMT is not a Perfect Theory

- ▶ KMT, kinetic molecular theory, is a model to explain the behavior of gases.
- ▶ The KMT is a very good model. It is a very good approximation of real gas behavior.
- ▶ All gas laws discussed in this chapter assume the KMT and are therefore approximate solutions for real gas behavior.
- ▶ Only an ideal gas is a perfect fit for the KMT.
- ▶ Real gases are not ideal, and do not fully fit the postulates of the KMT.
- ▶ Real gases diverge from ideal behavior at very low temperatures or very high pressures.

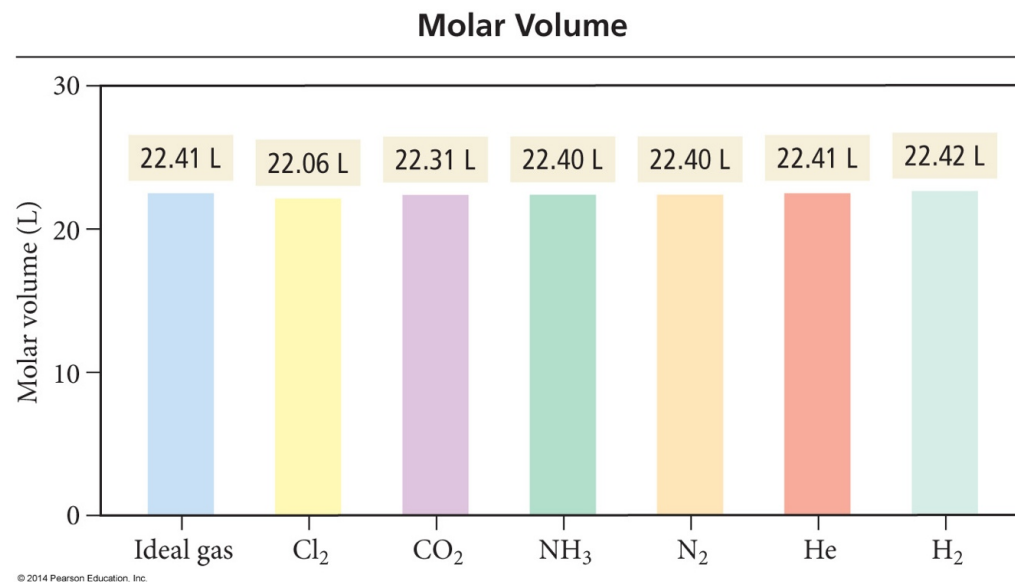



# KMT is not a Perfect Theory

- ▶ KMT, kinetic molecular theory, is a model to explain the behavior of gases.
- ▶ The KMT is a very good model. It is a very good approximation of real gas behavior.
- ▶ All gas laws discussed in this chapter assume the KMT and are therefore approximate solutions for real gas behavior.
- ▶ Only an ideal gas is a perfect fit for the KMT.
- ▶ Real gases are not ideal, and do not fully fit the postulates of the KMT.
- ▶ Real gases diverge from ideal behavior at very low temperatures or very high pressures.
- ▶ At **low temperatures** the attractive forces between them become significant.
- ▶ We will talk more about attractive forces between molecules in Ch 11.

## Nonideal Behavior: The effect of intermolecular forces

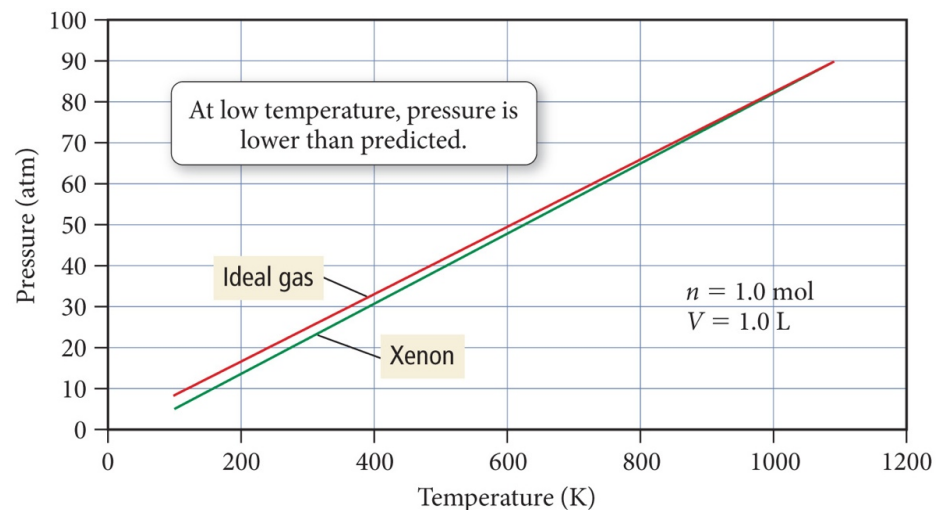

© 2014 Pearson Education, Inc.

Low Temperatures

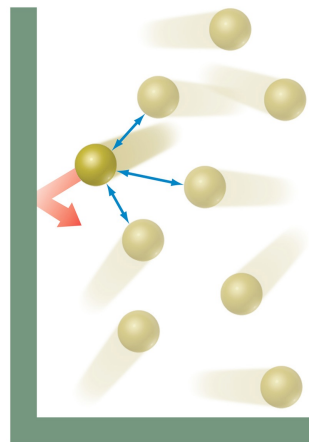

# KMT is not a Perfect Theory

- ▶ KMT, kinetic molecular theory, is a model to explain the behavior of gases.
- ▶ The KMT is a very good model. It is a very good approximation of real gas behavior.
- ▶ All gas laws discussed in this chapter assume the KMT and are therefore approximate solutions for real gas behavior.
- ▶ Only an ideal gas is a perfect fit for the KMT.
- ▶ Real gases are not ideal, and do not fully fit the postulates of the KMT.
- ▶ Real gases diverge from ideal behavior at very low temperatures or very high pressures.
- ▶ At **high pressures** the finite volume of particles becomes significant.

## Nonideal Behavior: The effect of particle volume

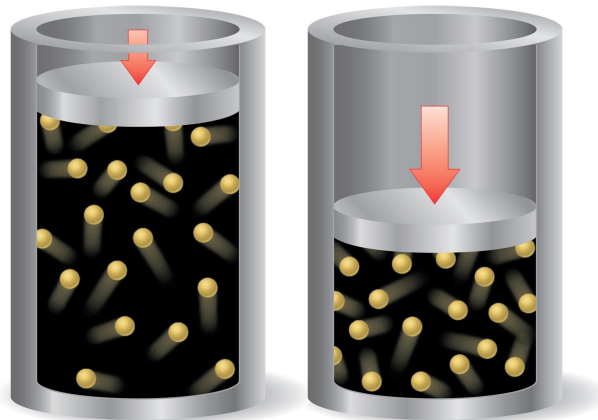
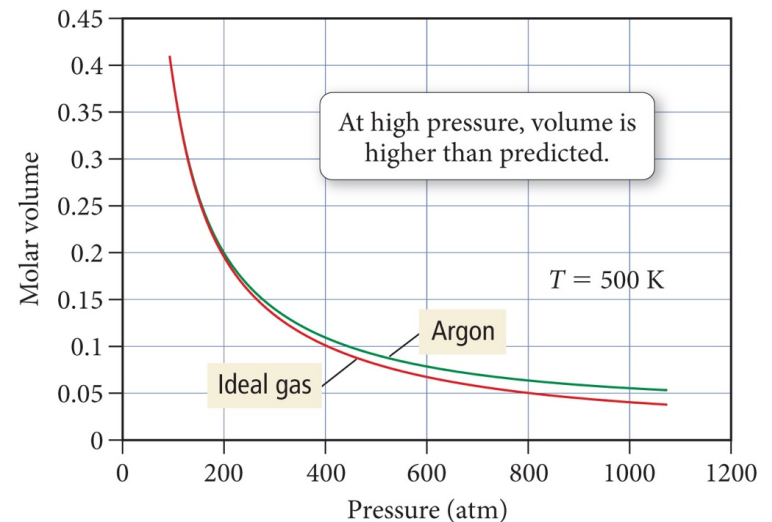

High Pressures



# KMT is not a Perfect Theory

- ▶ KMT, kinetic molecular theory, is a model to explain the behavior of gases.
- ▶ The KMT is a very good model. It is a very good approximation of real gas behavior.
- ▶ It's possible to improve KMT and the ideal gas law to account for these limitations, but it adds a level of complexity that normally is unnecessary and burdensome.

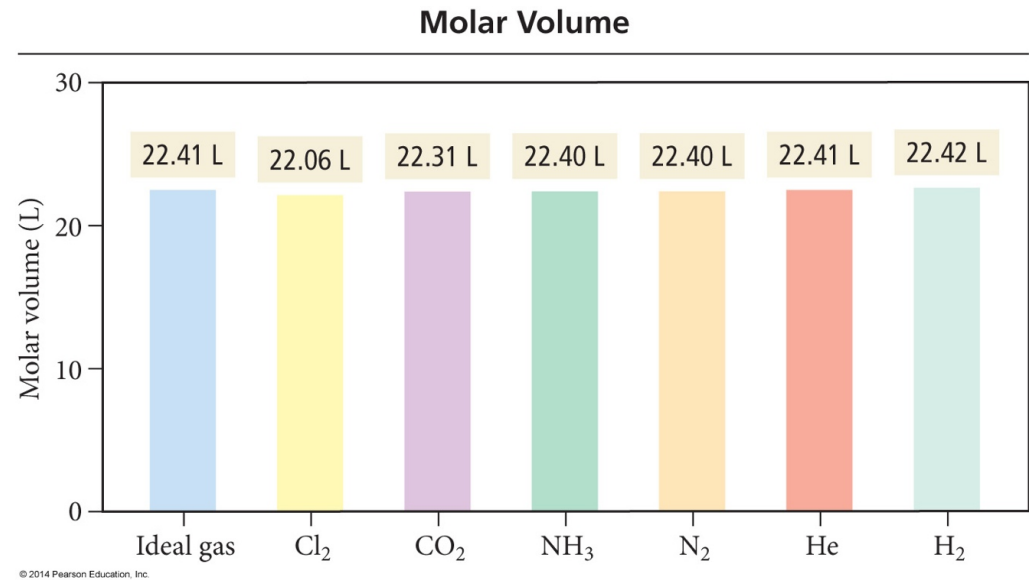

## Van der Waals Equation

$$\left[ P + a\left(\frac{n}{V}\right)^2 \right] \times [V - nb] = nRT$$

Correction for  
intermolecular forces

Correction for  
particle volume

© 2014 Pearson Education, Inc.

But it's close  
enough!



# Gas State of Matter

- ▶ Gas State
  - ▶ What's unique about gases?
  - ▶ Measuring those properties (V,T,n)
- ▶ Pressure
  - ▶ What is pressure (P)?
    - ▶ Standard Temp. & Pressure (STP)
  - ▶ Instruments and units of pressure.
- ▶ The Simple Gas Laws
  - ▶ Robert Boyle
    - ▶ Scientific Method; P and V; Boyle's Law
  - ▶ Jacques Charles
    - ▶ The Kelvin Scale; V and T Charles' Law
  - ▶ Joseph Gay-Lussac
    - ▶ The composition of water; T and P Gay-Lussac's Law
- ▶ Combining the Gas Laws
  - ▶ The Combined Gas Law
- ▶ Ideal Gas Theory
  - ▶ Atomic Theory
    - ▶ What is an ideal gas?
  - ▶ Avogadro's Law
  - ▶ Ideal Gas Law
    - ▶ The Ideal Gas Constant (R)
    - ▶ Molar Volume / Gas Stoichiometry
    - ▶ Gas Density
    - ▶ Molar Mass
- ▶ Gas Mixtures
  - ▶ Dalton's Law of Partial Pressures
    - ▶ Mole Fraction
  - ▶ Capturing Gases in the Lab
    - ▶ Vapors & Vapor Pressure
- ▶ Real Gases
  - ▶ Non-ideal conditions

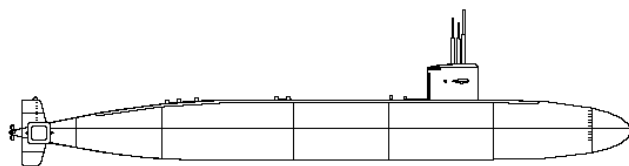
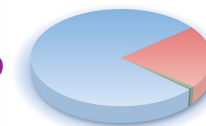
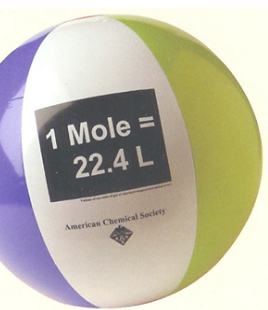



Questions?

